

HCONTROLS

PARTS CATALOG

TRAILER CONTROL SYSTEMS



Table of Contents

Height Control Valves

Overview	2
Height Control Valves — Drum Brake	2
Height Control Valves — Disc Brake	5
Aftermarket	6

Load Scales

Overview	7
Load Scale Decals	7
Load Scales — Polycarbonate Box	8
Load Scales — Stainless Steel Box	9
Aftermarket	9

Lift Axle Controls

Overview	10
Electric / Manual Lift Controls	10
Reverse Lift Axle Control	11
Manual Lift Controls	11

Dump Valves

Overview	12
Dump Valves — Manual	12
Dump Valves — Automatic / Specialty	14
Aftermarket	14

QUIK-DRAW® Valves

Overview	15
QUIK-DRAW Valves	15
Aftermarket	16

SURELOK® Controls

Overview	17
SURELOK Controls	17
Aftermarket	17

Single Axle Dump System

Single Axle Dump System	18
-----------------------------------	----



Height Control Valves

Trailer air suspension systems require precise air flow management. Using advanced Shear-Seal® technology to help ensure accurate airflow, Hendrickson Height Control Valves (HCVs) deliver superior performance and durability.

- ◆ Precise, highly repeatable dead band
- ◆ High air flow and a proportional response
- ◆ Help prolong air spring and shock absorber life
- ◆ Specifically designed and tested for optimum performance with Hendrickson air suspensions

Height Control Valves — Drum Brake

Product Family	Suspension Model	Axle Diameter	Dump Feature		No Pressure Protection Valve	No 90-degree Brass Fittings	Part Number
			Without	With			
INTRAAX®	AANT 23K	5 inch / 5.75 inch LDA™	X				AKH0270-3
			X		X		AKH0270B-3
				X			AKHD0270-3
				X	X		AKHD0270B-3
				X		X	AKHD0270F-3
	AAT 23K AAT 25K AAT 30K	5 inch / 5.75 inch LDA	X				AKH-238-3
			X		X		AKH-238B-3
				X			AKHD-238-3
				X		X	AKHD-238F-3
	AAEDT 30K	5 inch	X				AKH-235-3
			X		X		AKH-235B-3
				X			AKHD-235-3
	AANLS 20K	5 inch	X				AKH0275-3
				X			AKHD0275-3
	AANL 23K	5.75 inch LDA	X				AKH0292-3
			X		X		AKH0292B-3
				X			AKHD0292-3
				X		X	AKHD0292F-3
	AAL 23K AAL 25K AAL 30K AAEDL 30K	5 inch	X				AKH-235-3
			X		X		AKH-235B-3
				X			AKHD-235-3
				X			AKH0306-3
	AAL 23K AAL 25K AAL 30K	5.75 inch LDA	X				AKH0306B-3
			X		X		AKHD0306-3
			X			AKHD0306F-3	
			X		X	AKHD0306F-3	
CONNEX™	CXU 23K CXU 25K	5 inch	X				AKH-236-3
			X		X		AKH-236B-3
				X			AKHD-236-3
				X		X	AKHD-236F-3
HT™ Series	HT190T / HT190U HT230 HT250T / HT250U HT300T / HT300U HTHKR	5 inch	X				AKH-134-3
			X		X		AKH-134B-3
				X			AKHD-195-3
			X		X		AKH-179-2
	HT250US HT300US	5 inch	X				AKH-236-3
			X		X		AKH-236B-3
			X			X	AKH-236F-3
				X			AKHD-236-3
		X		X	AKHD-236F-3		
T Series	All Models	5 inch	X				AKH-239-3
				X			AKHD-239-3



AKH-181-3



AKHD-235-3

Product Family	Suspension Model	Axle Diameter	Dump Feature		No Pressure Protection Valve	No 90-degree Brass Fittings	Part Number
			Without	With			
VANTRAX®	HKANT 23K HKANT 40K HKANT 46K HKAT 50K HKAT 69K23 HKAT 69K25 HKANT 69K23	5 inch / 5.75 inch LDA™	X				AKH-181-3
				X			AKHD-203-3
	HKAL 46K HKARL 46K	5 inch	X				AKH-235-3
			X		X		AKH-235B-3
				X			AKHD-235-3
	HKANL 23K HKAL 46K HKARL 46K	5.75 inch LDA	X				AKH0306-3
			X		X		AKH0306B-3
				X			AKHD0306-3
				X		X	AKHD0306F-3
	HK™ Series	HK190 HK230	5 inch	X			
				X			AKHD-205-3
INTRAAX® SP	AAZNT 23K AAZNT 46K AAZNT 69K	5 inch / 5.75 inch LDA	X				AKH0270-3
			X		X		AKH0270B-3
				X	X		AKHD0270-3
				X		X	AKHD0270F-3
	AAZL 23K AAZL 46K	5 inch	X				AKH-235-3
			X		X		AKH-235B-3
				X			AKHD-235-3
	AAZL 23K AAZL 46K	5.75 inch LDA	X				AKH0306-3
			X		X		AKH0306B-3
				X			AKHD0306-3
				X		X	AKHD0306F-3

Kits listed include height control valve, mounting brackets, 3/8-inch tube fittings and bolted link assembly.



Bulk Height Control Valves — Drum Brake

Suspension Model	Kit Description	Part Number
AAL, AAEDL, AAEDT, CXU, HT250US, HT300US, HKAL, AAZL	Height Control Valve, Bulk 50 (includes A-28651 long arm)	AKH0249 ¹
AANT, AAT, AANL, AANLS, HT, HKANT, HKAT, HK, HTHKR, HKARL, HS, AAZNT	Height Control Valve, Bulk 50 (includes A-28648 short arm)	AKH0250
AAL, AAEDL, AAEDT, CXU, HT250US, HT300US, HKAL, AAZL	Integral Dump Height Control Valve, Bulk 35 (includes A-29391 long arm)	AKHD0249
AANT, AAT, AANL, AANLS, HT, HKANT, HKAT, HK, HTHKR, HKARL, HS, AAZNT	Integral Dump Height Control Valve, Bulk 35 (includes A-29393 short arm)	AKHD0250

¹ The long arm HCV can be used on short arm HCV applications. However, the installer must remove the end of the arm and use the bolt hole in the arm that is closest to the valve body.

Height Control Valve Hardware Kits — Drum Brake

Suspension Model	Axle Diameter	Fasteners	Mounting Brackets	No 90-degree Brass Fittings	Bolted Link Assembly	Part Number
AAT	5 inch / 5.75 inch LDA™	X	X		X	AKH0252
		X	X	X	X	AKH0252F
		X	X	X		AKH0252-1
AAL, AAEDL, AAEDT, HKAL, HKARL, AAZL	5 inch	X	X		X	AKH0253
		X	X	X		AKH0253-1
AAL, HKAL, HKARL, AAZL	5.75 inch LDA	X	X		X	AKH0309
		X	X	X		AKH0309-1
HKANT, HKAT	5 inch / 5.75 inch LDA	X	X		X	AKH0256
		X	X	X		AKH0256-1
AANT, AAZNT	5 inch / 5.75 inch LDA	X	X		X	AKH0262
		X	X	X		AKH0262-1
AANL	5.75 inch LDA	X	X		X	AKH0289
		X	X	X		AKH0289-1
AANLS	5 inch	X	X		X	AKH0290
		X	X	X		AKH0290-1

Specialty Height Control Valves — Drum and Disc Brake

Product Family	Suspension Model	Brake Type	Dump Feature		No Pressure Protection Valve	No 90-degree Brass Fittings	Kit Description	Part Number
			Without	With				
INTRAAX®	AAT at 14 inch RH	Drum	X		X		Tube fittings not included; supplied with fixed bolt link	AKH-244B
	AANLS 20K	Drum	X				Includes a U-bolt for mounting the HCV	AKH0266-3
			X		X			AKH0266B-3
				X				AKHD0266-3
				X	X	X		AKHD0266B-3
		Disc	X					AKH0311-3
				X				AKHD0311-3
		X	X	X	AKHD0311B-3			
HT™ Series	HT250US/HT300US at 6.5 inch RH	Drum	X		X		Tube fittings not included; supplied with fixed bolt link	AKH-242B
VANTRAAX®	HRRNT 40K	Drum	X				Tube fittings not included	AKH0261
INTRAAX® SP	AAZL (5 inch)	Drum	X				Includes a valve to raise the trailer for slider positioning	AKH0267-3
			X		X			AKH0267B-3
	AAZL (5.75 inch LDA)	Drum	X					AKH0310-3



Height Control Valves — Disc Brake

Product Family	Suspension Model	Axle Diameter	Dump Feature		No Pressure Protection Valve	No 90-degree Brass Fittings	Part Number
			Without	With			
INTRAAX®	AANLS 20K	5 inch	X				AKH0312-3
				X			AKHD0312-3
	AANT 23K	5 inch	X				AKH0281-3
				X			AKHD0281-3
	AANT 23K AANL 23K	5.75 inch LDA™	X				AKH0282-3
			X		X		AKH0282B-3
			X			X	AKH0282F-3
				X			AKHD0282-3
				X	X		AKHD0282B-3
				X		X	AKHD0282F-3
	AAT 23K AAT 25K AAT 30K AAL 23K AAL 25K AAL 30K AAEDL 30K AAEDT 30K	5 inch	X				AKH-235-3
			X		X		AKH-235B-3
				X			AKHD-235-3
	AAL 23K AAL 25K AAL 30K	5.75 inch LDA	X				AKH0306-3
			X		X		AKH0306B-3
				X			AKHD0306-3
				X		X	AKHD0306F-3
	AAT 23K AAT 25K AAT 30K	5.75 inch LDA	X				AKH0288-3
			X		X		AKH0288B-3
				X			AKHD0288-3
			X	X		AKHD0288B-3	
VANTRAAX®	HKAT 50K HKAT 69K25	5 inch	X				AKH0283-3
				X			AKHD0283-3
	HKANT 23K HKANT 40K HKANT 46K HKAT 50K HKANT 69K23	5.75 inch LDA	X				AKH0284-3
				X			AKHD0284-3
	HKARL 46K	5.75 inch LDA	X				AKH0306-3
			X		X		AKH0306B-3
				X			AKHD0306-3
			X		X	AKHD0306F-3	
INTRAAX® SP	5 inch	5 inch	X				AKH0281-3
				X			AKHD0281-3
	AAZNT 23K AAZNT 46K AAZNT 69K	5.75 inch LDA	X				AKH0282-3
			X		X		AKH0282B-3
			X			X	AKH0282F-3
				X			AKHD0282-3
				X	X		AKHD0282B-3
				X		X	AKHD0282F-3

Kits listed include height control valve, mounting brackets, 3/8-inch tube fittings and bolted link assembly.



Aftermarket

Description	Suspension Model	Ride Height	Dump Feature		Fitting Style	Part Number ¹
			Without	With		
Replacement Height Control Valve	INTRAAX [®] CONNEX [™] HT [™] Series T Series VANTRAAX [®] HK [™] Series INTRAAX [®] SP	All	X		None	VS-227
				X	None	VS-228
	ULTRAA-K [®]	16"	X		Compression	VS-33704-3
				X		VS-33705-3
			X		PTC	VS-33704-4
	X	VS-33705-4				
Replacement DST [®] Valve (Height Control Differential Dump Valve)	VANTRAAX [®]	All		X	None	VS-27116
	ULTRAA-K [®]	16"		X	Compression PTC	VS-33703-3 VS-33703-4

¹ Kits listed do not include pressure protection valve or link assembly.



VS-227



VS-228

Description	Suspension Model	Ride Height	HCV Model	Part Number
Pressure Protection Valve	All	N/A	N/A	VS-38941
Bolted Link Assembly	INTRAAX [®] CONNEX [™] HT [™] Series T Series VANTRAAX [®] HK [™] Series INTRAAX [®] SP	All	VS-227 and VS-228	S-14187
Fixed Link Assembly	ULTRAA-K [®]	16"	VS-33703-3, VS-33703-4, VS-33704-3 VS-33704-4, VS-33705-3, VS-33705-4	VS-33702-1



VS-38941



S-14187

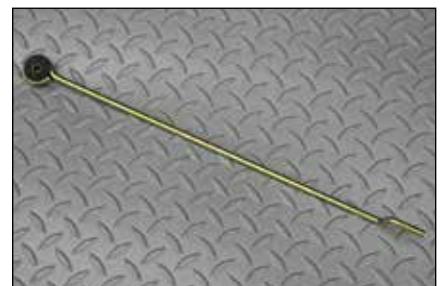

VS-33702-1



Load Scales

Hendrickson Load Scale kits provide an easy solution to quickly determine the approximate suspension load. Each contains a gauge that measures air pressure and a method for converting pressure to suspension load. Depending on the load scale model, the gauge provides a reading of suspension weight or a reading of air spring pressure with a conversion table.

- ◆ Compact enclosure size and external mounting tabs provided for convenient installation
- ◆ Integrated valve body reduces fittings and potential leak points
- ◆ Anodized aluminum valve body for light weight and high corrosion resistance
- ◆ Teflon seals ensure a wide operating temperature range and high chemical resistance
- ◆ Polycarbonate enclosure for cold impact resistance includes molded-in hinge and latch



AKLS1005



AKLS1006

Load Scale Decals — Liquid Filled Gauges

Product Family	Suspension Model	Part Number
INTRAAAX®	AANLS 20K	L912
	AAL, AAT, AANL, AANT 23K (Low Pressure Air Spring)	L912
	AAL, AAT, AANL, AANT 23K	L911
	AAEDL, AAEDT 30K	L927
	AAL, AAT 25K	L912
	AAL, AAT 30K	L913
INTRAAAX® SP	AAZNT, AAZL 23K	L911
	AAZNT, AAZL 46K	
	AAZNT 69K	
HT™ Series	HT190	L905
	HT190U	L903
	HT230	L914
	HT250T	L904
	HT250U at 9-inch Ride Height (Air Spring C-13122)	T90001
	HT250U at 15-inch Ride Height (Air Spring C-13122)	T90002
	HT250U, HT250US (Air Spring C-20124)	L904
	HT250U, HT250US (Air Spring C-20127)	L906
	HT300	L909
	HT300U	L908
	HT300US	T90004

Product Family	Suspension Model	Part Number
CONNEX™	CXU 23K	T90006
	CXU 25K	T90007
VANTRAAAX®	HKANT 23K, 46K, 69K23	L911
	HKANT 40K	L1045 ¹ L911 ²
	HKANT 40K with ZMD®	T90003
	HKAT 50K, 69K25	L912
	HKANL 23K	L911
	HKAL, HKARL 46K	L911
ULTRAA-K®	UTKNT 40K (Air Spring C-34733)	T90003
	UTKNT 40K (Air Spring C-38000)	L1045
HK™ Series	HK190T	L907
	HK230T	L910
	HTHKR	L910

¹ For HKANT 40K built in 2008 or later.

² For HKANT 40K built prior to 2008 or HKANT 40K with SMARTLIFT® option.

NOTE: The load scale decal is not included with the load scale kit. Determine the appropriate load scale kit for the suspension model specified and order the corresponding decal separately.

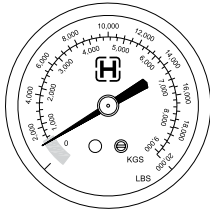

A

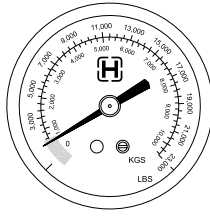

B

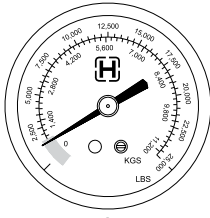

C

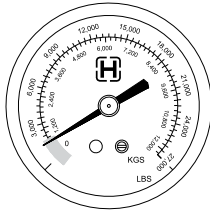

D

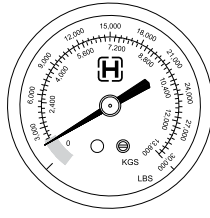

E

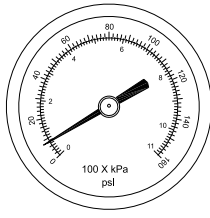

F

Load Scales — Polycarbonate Box

Product Family	Suspension Model	Gauge Type	Gauge Range	Gauge Face	Part Number	
					Without Dump (AKLS1005)	With Dump (AKLS1006)
INTRAAX®	AANLS 20K	Dry	0 - 25,000	C	-4	-4
	AAL, AAT, AANL, AANT 23K (Standard Air Spring)	Dry	0 - 23,000	B	-3	-3
	AAL, AAT, AANL, AANT 23K (Low Pressure Air Spring)	Dry	0 - 25,000	C	-4	-4
	AAL 25K, AAT 25K	Dry	0 - 25,000	C	-4	-4
	AAL 30K, AAT 30K	Dry	0 - 30,000	E	-6	-6
	AAEDL 30K, AAEDT 30K	Dry	0 - 30,000	E	-6	-6
INTRAAX® SP	AAZNT 23K, AAZNT 46K, AAZNT 69K	Dry	0 - 23,000	B	-3	-3
	AAZL 23K, AAZL 46K	Dry	0 - 23,000	B	-3	-3
HK™ Series	HK190T	Dry	0 - 23,000	B	-3	-3
	HK230T	Dry	0 - 23,000	B	-3	-3
VANTRAAX®	HKANT 23K, HKANT 46K	Dry	0 - 23,000	B	-3	-3
	HKANT 40K	Dry	0 - 20,000	A	-2	-2
	HKAT 50K, HKAT 69K25	Dry	0 - 25,000	C	-4	-4
	HKANT 69K23	Dry	0 - 23,000	B	-3	-3
	HKAT 69K23	Dry	0 - 23,000	B	-3	-3
	HKARL 46K	Dry	0 - 23,000	B	-3	-3
	HKANL 23K	Dry	0 - 23,000	B	-3	-3
	HKAL 46K	Dry	0 - 23,000	B	-3	-3
ULTRAA-K®	UTKNT 40K	Dry	0 - 20,000	A	-2	-2
CONNEX™	CXU 23K	Dry	0 - 23,000	B	-3	-3
	CXU 25K	Dry	0 - 25,000	C	-4	-4
HT™ Series	HTHKR	Dry	0 - 23,000	B	-3	-3
	HT190	Dry	0 - 20,000	A	-2	-2
	HT190U	Dry	0 - 23,000	B	-3	-3
	HT230	Dry	0 - 23,000	B	-3	-3
	HT250T	Dry	0 - 25,000	C	-4	-4
	HT250U (Air Spring C-2 0124)	Dry	0 - 25,000	C	-4	-4
	HT250U (Air Spring C-20127)	Dry	0 - 30,000	E	-6	-6
	HT250U (Air Spring C-13122, 9 inch Ride Height)	Dry	0 - 30,000	E	-6	-6
	HT250U (Air Spring C-13122, 15 inch Ride Height)	Dry	0 - 27,000	D	-5	-5
	HT250US (Air Spring C-20124)	Dry	0 - 25,000	C	-4	-4
	HT250US (Air Spring C-20127)	Dry	0 - 30,000	E	-6	-6
	HT300	Dry	0 - 30,000	E	-6	-6
	HT300U	Dry	0 - 30,000	E	-6	-6
HT300US	Dry	0 - 30,000	E	-6	-6	
T Series	T-6-068	Dry	0 - 25,000	C	-4	-4
	T-6-252	Dry	0 - 27,000	D	-5	-5
	T-RL	Dry	0 - 30,000	E	-6	-6
All	All Models	Liquid	0 - 160 psi	F	-1	-1



Load Scales — Stainless Steel Box

Product Family	Suspension Model	Gauge Type	Gauge Range	Gauge Face	Part Number	
					Without Dump (AKLS2005)	With Dump (AKLS2006)
INTRAAX®	AANLS 20K	Dry	0 - 25,000	C	-4	-4
	AAL, AAT, AANL, AANT 23K (Standard Air Spring)	Dry	0 - 23,000	B	-3	-3
	AAL, AAT, AANL, AANT 23K (Low Pressure Air Spring)	Dry	0 - 25,000	C	-4	-4
	AAL 25K, AAT 25K	Dry	0 - 25,000	C	-4	-4
	AAL 30K, AAT 30K	Dry	0 - 30,000	E	-6	-6
	AAEDL 30K, AAEDT 30K	Dry	0 - 30,000	E	-6	-6
INTRAAX® SP	AAZNT 23K, AAZNT 46K, AAZNT 69K	Dry	0 - 23,000	B	-3	-3
	AAZL 23K, AAZL 46K	Dry	0 - 23,000	B	-3	-3
HK™ Series	HK190T	Dry	0 - 23,000	B	-3	-3
	HK230T	Dry	0 - 23,000	B	-3	-3
VANTRAAX®	HKANT 23K, HKANT 46K	Dry	0 - 23,000	B	-3	-3
	HKANT 40K	Dry	0 - 20,000	A	-2	-2
	HKAT 50K, HKAT 69K25	Dry	0 - 25,000	C	-4	-4
	HKANT 69K23, HKAT 69K23	Dry	0 - 23,000	B	-3	-3
	HKARL 46K	Dry	0 - 23,000	B	-3	-3
	HKANL 23K	Dry	0 - 23,000	B	-3	-3
	HKAL 46K	Dry	0 - 23,000	B	-3	-3
ULTRAA-K®	UTKNT 40K	Dry	0 - 20,000	A	-2	-2
CONNEX™	CXU 23K	Dry	0 - 23,000	B	-3	-3
	CXU 25K	Dry	0 - 25,000	C	-4	-4
HT™ Series	HTHKR	Dry	0 - 23,000	B	-3	-3
	HT190	Dry	0 - 20,000	A	-2	-2
	HT190U	Dry	0 - 23,000	B	-3	-3
	HT230	Dry	0 - 23,000	B	-3	-3
	HT250T	Dry	0 - 25,000	C	-4	-4
	HT250U (Air Spring C-20124)	Dry	0 - 25,000	C	-4	-4
	HT250U (Air Spring C-20127)	Dry	0 - 30,000	E	-6	-6
	HT250U (Air Spring C-13122, 9 inch Ride Height)	Dry	0 - 30,000	E	-6	-6
	HT250U (Air Spring C-13122, 15 inch Ride Height)	Dry	0 - 27,000	D	-5	-5
	HT250US (Air Spring C-20124)	Dry	0 - 25,000	C	-4	-4
	HT250US (Air Spring C-20127)	Dry	0 - 30,000	E	-6	-6
	HT300	Dry	0 - 30,000	E	-6	-6
	HT300U	Dry	0 - 30,000	E	-6	-6
HT300US	Dry	0 - 30,000	E	-6	-6	
T Series	T-6-068	Dry	0 - 25,000	C	-4	-4
	T-6-252	Dry	0 - 27,000	D	-5	-5
	T-RL	Dry	0 - 30,000	E	-6	-6
All	All Models	Liquid	0 - 160 psi	F	-1	-1

Aftermarket

Description	Load Scale Model	Part Number
Replacement Polycarbonate Enclosure	AKLS1005	VS-31845-3
Replacement Polycarbonate Enclosure	AKLS1006	VS-31845-2
Replacement Stainless Steel Enclosure	AKLS2005, AKLS2006	VS-32312
Replacement Liquid-Filled Gauge	All -1 Models with Liquid Gauge	VS-24120
Replacement Dry Gauge	All -2 Models with Dry Gauge	VS-22534-1
	All -3 Models with Dry Gauge	VS-22534-2
	All -4 Models with Dry Gauge	VS-22534-3
	All -5 Models with Dry Gauge	VS-22534-4
	All -6 Models with Dry Gauge	VS-22534-5



Lift Axle Controls

Electric / Manual Lift Controls

Specify Hendrickson's popular line of electric/manual lift axle controls to simplify trailer plumbing. The compact design incorporates an electric solenoid, manual operator, lift bag valve and ride bag valve into one integrated body. For regulated versions, the regulator and gauge are incorporated into the main valve body to eliminate the need for external plumbing and fittings.

- ◆ Modular, high flow design is available in regulated and equalizing versions
- ◆ Designed to perform in harsh trailer environments with or without an enclosure
- ◆ Fail mode is field configurable from "normally down" to "normally up"

Mounting Option		Valve Configuration		Brake Isolation		Part Number
Stainless Steel Enclosure	Mounting Bracket	Regulating	Equalizing	Without	With	
	X		X	X		AKAD0008-1
	X		X		X	AKAD0008-2 ¹
	X	X		X		AKAD0009-1
	X	X			X	AKAD0009-2 ¹
X			X	X		AKAD2010-1
X			X		X	AKAD2010-2 ¹
X		X		X		AKAD2011-1
X		X			X	AKAD2011-2 ¹

¹ The brake isolation feature requires a brake relay (not available from Hendrickson). When plumbed, the brake relay controls the pressure to the liftable suspension brakes independently of the primary suspension brakes.

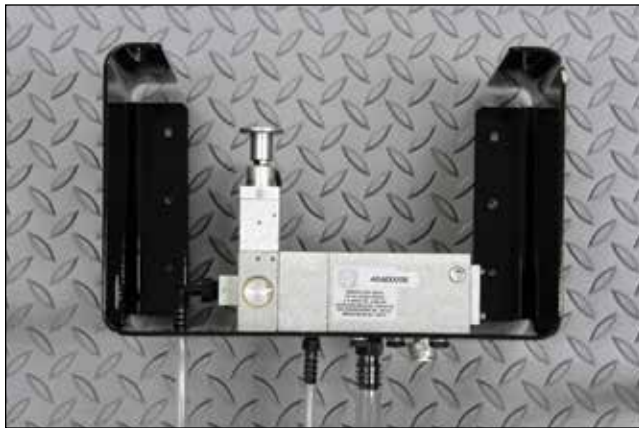

AKAD0008



AKAD2011

Aftermarket

Description	Lift Axle Model	Part Number
Replacement Mounting Bracket	AKAD0008-1, AKAD0008-2 AKAD0009-1, AKAD0009-2	VS-31531
Replacement Stainless Steel Enclosure	AKAD2010-1, AKAD2010-2 AKAD2011-1, AKAD2011-2	VS-31557



Reverse Lift Axle Control

- ◆ For use with liftable/steerable trailer axles
- ◆ Moving in reverse 3 feet automatically keys lifting of axle
- ◆ Moving forward 80 feet automatically triggers lowering of axle
- ◆ To be used in conjunction with electro-pneumatic lift controls: AKAD0008, AKAD0009, AKAD2010 and AKAD2011

Description	Brake Type	Part Number
Automatic Lift Axle Control Kit	Drum	EKAD0001
	Disc	EKAD0001-1



EKAD0001

Manual Lift Controls

- ◆ Available in regulating and equalizing versions
- ◆ The Dial-A-Ride control utilizes a convenient mounting panel

Description	Valve Configuration	Part Number
Manual Dial-A-Ride	Regulating	VS-1314-C
Manual	Equalizing	AKAM0001



VS-1314-C



AKAM0001



Dump Valves

Hendrickson offers a wide variety of dump valve kits. Dump valves are typically used to exhaust the air from the suspension during loading and unloading. Exhausting the suspension helps prevent trailer walk, provides increased stability and lowers the trailer deck height.

Manual Dump Valves

- ◆ Rated for -40° F to 180° F
- ◆ Highly tolerant to contamination and chemicals
- ◆ Anodized aluminum construction for superior corrosion resistance and strength
- ◆ Stainless steel shaft for better wear and corrosion resistance
- ◆ Protected vent prevents contamination from entering the valve

Box Type			Auto Reset		Liquid Gauge		Part Number
None	Polycarbonate	Stainless Steel	Without	With	Without	With	
	X		X		X		AKEM1007-1
	X		X			X	AKEM1007-2
	X			X	X		AKER1004-1
	X			X		X	AKER1004-2
		X	X		X		AKEM2006-1
		X	X			X	AKEM2006-2
		X		X	X		AKER2003-1
		X		X		X	AKER2003-2
X			X	X	X		AKEM0005-1 ¹
X			X	X	X		AKEM0005-2 ^{1,2} (Includes auto dump)

¹ Can be used as an auto-reset valve by removing the vent protector.

² Provides a manual dump control and a remote auto reset dump that is activated by the trailer parking brakes.

Manual Dump Valves



AKEM0005-1



AKER1004-2



AKEM2006-2



AKER2003-1



Automatic / Specialty Dump Valves

Description	Box Type		Valve Type			Auto Reset		Compatible with SURELOK®		Part Number
	None	Polycarbonate	Manual	Electric	Auto	Without	With	Yes	No	
Ball Valve	X		X			X			X	AK-147-1
Ball Valve		X	X			X			X	AKEM1008
Solenoid Valve	X			X		X			X	AK-53
Auto Dump	X				X		X		X	AK-54
Integral Auto Dump	X				X		X		X	AKHD-XXX ¹

¹ Automatic dump feature is integrated into the height control valve. Reference the Height Control Valve section for specific kit numbers.



AK-53



AK-54



AK-147-1

Aftermarket

Description	Dump Valve Model	Part Number
Replacement Polycarbonate Enclosure	AKEM1007-1, AKEM1007-2	VS-31335
Replacement Polycarbonate Enclosure	AKER1004-1, AKER1004-2	VS-31325
Replacement Stainless Steel Enclosure	AKEM2006-1, AKEM2006-2 AKER2003-1, AKER2003-2	VS-31320
Replacement Mounting Bracket	AKEM0005-1, AKEM0005-2	VS-30427

QUIK-DRAW® Pneumatic Pin-Pull Mechanism

Hendrickson’s VANTRAAX® and INTRAAX® SP air suspension slider systems come standard with the QUIK-DRAW pneumatic pin-pull mechanism. Triggered with a simple pull of a knob, it applies continuous pressure until the pins release. Pins automatically reset with the release of the emergency brake. For instances when additional features are required and an enclosure is preferred, a variety of QUIK-DRAW kits are also available.

- ◆ A complete pneumatic pin-pull mechanism for demanding applications
- ◆ Helps enhance driver productivity and satisfaction
- ◆ Tested to meet stringent durability and environmental conditions — operating in temperatures to -40 degrees

QUIK-DRAW Valves

Box Type		Auto Reset		Dump Feature		Liquid Gauge		SURELOK® Bypass	Part Number
Polycarbonate	Stainless Steel	Without	With	Without	With	Without	With		
X			X	X		X			AKQD1008
X			X ¹		X	X			AKQD1009 ¹
X			X ¹		X		X		AKQD1010 ¹
X			X ¹		X	X		X	AKQD1011 ¹
	X		X ¹		X	X			AKQD2006 ¹

¹ Auto reset function resets the QUIK-DRAW valve only, not the manual dump.



AKQD1008



AKQD1011



Aftermarket

Description	Product Family	Part Number	Notes
3-way Auto Reset Valve, No Fittings	VANTRAAX®, ULTRAA-K®, INTRAAX® SP	VS-25223	
3-way Auto Reset Valve, Straight Fittings	VANTRAAX, ULTRAA-K, INTRAAX SP	VS-25224	Valve Assembly Only
	ULTRAA-K	VS-33759	Valve Assembly with Bracket
		VS-41590-1	Valve Assembly Only, For Units built Nov. 2022 or After
		VS-41535-1	Valve Assembly with Bracket, For Units built Nov. 2022 or After
3-way Auto Reset Valve, Straight and Tee Fittings	VANTRAAX	VS-29866	
	ULTRAA-K	VS-34932	Valve Assembly Only
		VS-33760	Valve Assembly with Bracket
		VS-41592-1	Valve Assembly Only, For Units built Nov. 2022 or After
		VS-41536-1	Valve Assembly with Bracket, For Units built Nov. 2022 or After
Replacement Polycarbonate Enclosure	AKQD1008, AKQD1009, AKQD1010	VS-31845-4	
	AKQD1011	VS-31845-6	



VS-25223



VS-25224

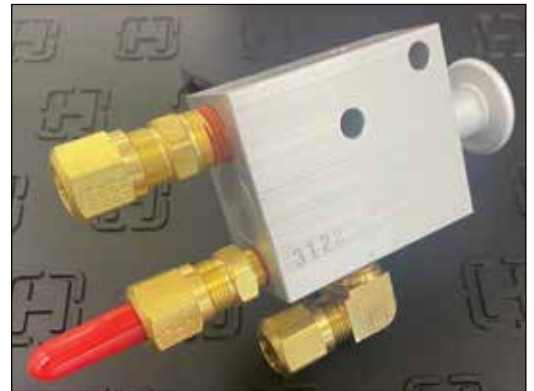

VS-29866



VS-41590-1



VS-41592-1



SURELOK® Controls

Hendrickson’s SURELOK controls feature locking legs that provide maximum engagement with the suspension beam. Designed for the customer who must maintain ride height during loading and unloading, SURELOK automatically engages when the trailer’s parking brakes are set. SURELOK is an available option on VANTRAAX® air suspension slider systems or can be purchased separately for use in a variety of other Hendrickson suspensions. For instances when additional features are required and an enclosure is preferred, a variety of SURELOK controls are also available.

- ◆ Maintains ride height during loading / unloading for efficient trailer dock operations
- ◆ Helps eliminate trailer walk by limiting suspension vertical and horizontal movement

SURELOK Controls

Polycarbonate Box	Auto Reset		Dump Feature		Liquid Gauge		SURELOK Bypass	Part Number
	Without	With	Without	With	Without	With		
X	X		X		X		X	AKSL1002
X	X			X	X		X	AKSL1003
X		X		X	X		X	AKSL1004
X		X		X		X	X	AKSL1004-1



AKSL1002



AKSL1004-1

Aftermarket

Description	SURELOK Model	Part Number
Replacement Polycarbonate Enclosure	AKSL1002	VS-31845-7
	AKSL1003	VS-31845-2
	AKSL1004	VS-31845-8
	AKSL1004-1	VS-31845-9



Single Axle Dump System

Hendrickson's single axle dump system gives operators an effective solution to improve low speed maneuverability. Under certain conditions, it will allow the operator to exhaust the air from one suspension. The system automatically monitors trailer speed and only activates at speeds less than 10 mph. Requires upgraded ABS valve ECU with applicable software. (Supplied by ABS manufacturer.)

- ◆ Provides fast exhaust without the need for an additional relay valve — dumps in less than 2 seconds
- ◆ Consumes less air than other relay valve systems
- ◆ Utilizes Hendrickson's proprietary speed-control reset
- ◆ Tested to meet stringent durability and environmental conditions - operating in temperatures as low as -40 degrees
- ◆ Effectively exhausts air springs under various loading conditions, including lightly loaded trailers with low air spring pressures
- ◆ Hendrickson approved — speed limiting feature maintains Hendrickson's suspension and wheel-end warranty

Single Axle Dump System



Single Axle Dump Valve

ABS Compatibility	Part Number
Wabco	AKES0001
Bendix	AKES0002
Hallex	AKES0003

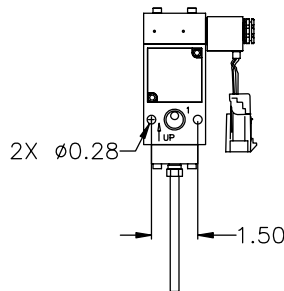

Rear Axle Dump Valve

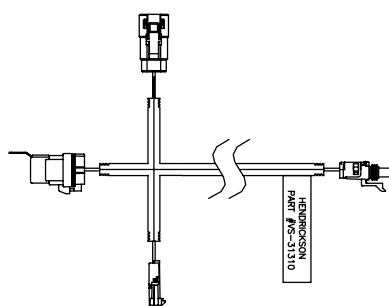

System Harness

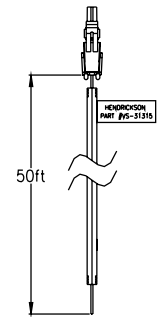

Actuation Harness

NOTE: Requires application approval from Hendrickson.



*Actual product performance may vary depending upon vehicle configuration, operation, service and other factors.
 All applications must comply with applicable Hendrickson specifications and must be approved by the respective vehicle manufacturer with the vehicle in its original, as-built configuration.
 Contact Hendrickson for additional details regarding specifications, applications, capacities, and operation, service and maintenance instructions.*

Call Hendrickson at 866.RIDEAIR (743.3247) for additional information.



www.hendrickson-intl.com

TRAILER COMMERCIAL VEHICLE SYSTEMS
 2070 Industrial Place SE
 Canton, OH 44707-2641 USA
 866.RIDEAIR (743.3247)
 Fax 800.696.4416

Hendrickson Canada ULC
 2825 Argenta Road, Unit #2 - 4
 Mississauga, ON Canada L5N 8G6
 800.668.5360
 905.789.1030 • Fax 905.812.9423

Hendrickson Mexicana
 Circuito El Marqués Sur #29
 Parque Industrial El Marqués
 Pob. El Colorado, Municipio El Marqués,
 Querétaro, México C.P. 76246
 +52 (442) 296.3600 • Fax +52 (442) 296.3601

L1182 Rev K 07-23

© 2011 - 2023 Hendrickson USA, L.L.C. All Rights Reserved. All trademarks shown are owned by Hendrickson USA, L.L.C., or one of its affiliates, in one or more countries, except for Shear-Seal, which is owned by Barksdale, Inc. Information contained in this literature was accurate at the time of publication. Product changes may have been made after the copyright date that are not reflected.

Printed in United States of America