



059310-017



ASSEMBLY INSTRUCTIONS

STEERTEK™ NXT • STEERTEK Axle

SUBJECT: Thrust Bearing Service Kits
STEERTEK NXT: 60961-631, 60961-632, 60961-633
STEERTEK: 60961-043, 60961-041, 60961-042

LIT NO: 59310-017

DATE: May 2020

REVISION: C

INTRODUCTION

Hendrickson equips STEERTEK™ NXT • STEERTEK axles with two different configurations of thrust bearings for the left and right steering knuckle assemblies, depending upon the vehicle make, model and intended application.

The primary configuration includes:

- **One Composite Thrust Bearing** – installed on the kingpin of the left steering knuckle assembly to provide proper damping performance; and
- **One Roller Thrust Bearing** – installed on the kingpin of the right steering knuckle assembly to provide proper steering returnability and road feel, see Figure 1.

The less common configuration includes:



- **Two Roller Thrust Bearings** – installed on the kingpins of both steering knuckle assemblies.

For the primary configuration, the composite and roller thrust bearings must not be interchanged. Failure to install the composite bearing in the proper location (left side) will not allow the STEERTEK NXT • STEERTEK axle to achieve maximum damping performance. Both thrust bearings are to be installed with the seal against the underside of the axle.

Hendrickson offers a series of thrust bearing service kits, as listed in the above table, for use with STEERTEK NXT • STEERTEK axles on an as-needed basis. Each service kit should be selected and used in accordance with the original factory thrust bearing configuration. These service kits are intended to help address any steering returnability, wandering, damping, or grease purge concerns. Note, separate Hendrickson kingpin bushing replacement service kits also contain the corresponding replacement thrust bearings.

The STEERTEK NXT • STEERTEK axle is a component of the AIRTEK® NXT, AIRTEK, SOFTEK® NXT and SOFTEK suspension systems. Please refer to the applicable Hendrickson AIRTEK® NXT, AIRTEK, SOFTEK® NXT and SOFTEK technical publications (available at www.hendrickson-intl.com) for further information regarding safety notices, proper inspection, maintenance and service of the STEERTEK NXT • STEERTEK axle.

Thrust Bearing Service Kits

STEERTEK NXT	STEERTEK
60961-631 Axle Set (includes 60961-632 and 60961-633) 60961-632 Composite* 60961-633 Roller*	60961-043 Axle Set (includes 60961-041 and 60961-042) 60961-041 Composite* 60961-042 Roller*
 Shown 60961-631	 Shown 60961-043
CONTENTS	CONTENTS
Thrust Bearing • Left Side (Composite) or • Right Side (Roller)	Thrust Bearing • Left Side (Composite) or • Right Side (Roller)
Kingpin Seals	Kingpin Seals
5/8"-11 UNC Socket Head Cap Screws	5/8"-11 UNC Socket Head Cap Screws
Loctite Tube	Loctite Tube
	Kingpin Shims
NOTE: * Each kit is intended for service of one steering knuckle assembly.	





STEERING KNUCKLE ASSEMBLY

CAUTION

A TECHNICIAN USING A SERVICE PROCEDURE OR TOOL WHICH HAS NOT BEEN RECOMMENDED BY HENDRICKSON MUST FIRST SATISFY HIMSELF THAT NEITHER HIS SAFETY NOR THE VEHICLE'S SAFETY WILL BE JEOPARDIZED BY THE METHOD OR TOOL SELECTED. INDIVIDUALS DEVIATING IN ANY MANNER FROM THE INSTRUCTIONS PROVIDED ASSUME ALL RISKS OF POTENTIAL PERSONAL INJURY OR DAMAGE TO EQUIPMENT INVOLVED.

ASSEMBLY

As mentioned previously, the primary thrust bearing configuration for STEERTEK NXT • STEERTEK axles includes (1) a composite thrust bearing installed on the left steering knuckle assembly and (2) a roller thrust bearing installed on the right steering knuckle assembly, see Figure 1. **DO NOT** interchange the locations of the composite and roller thrust bearings during servicing.

The other less common thrust bearing configuration includes roller thrust bearings installed on both the left and right side steering knuckle assemblies.

FIGURE 1

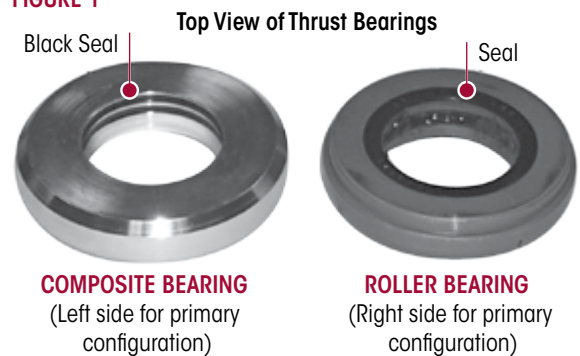

1. Install the replacement thrust bearing on the lower kingpin with the seal facing up toward axle (the black seal will designate the top side, see Figure 1).
 - For the above-referenced primary configuration, the composite thrust bearing is to be installed on the left side of the axle and the roller thrust bearing is to be installed on the right side of the axle.
 - For the other less common configuration, a roller thrust bearing is to be installed on both sides of the axle. Each service kit should be selected and used in accordance with the original factory thrust bearing configuration.
2. **STEERTEK** axle only – Install the shim(s) if equipped on the upper kingpin.
3. Pack the bushing dimples on the upper and lower steering knuckles with multi purpose Lithium based grease (NLGI Grade 2) before installation.
4. Install the upper steering knuckle on the upper arm kingpin.
5. Install the lower steering knuckle on the lower kingpin and install the old socket head cap screws loose into the top two (2) threaded holes.

SERVICE HINT

The easiest way to achieve this is with the grease caps temporarily removed from the knuckle assemblies. This eliminates back pressure. The assembly can then freely slide up and down on the kingpin. If the grease caps are still installed, remove the grease zerks to avoid creating back pressure. All such grease caps and/or zerks must be re-installed at the end of the procedure.

FIGURE 2

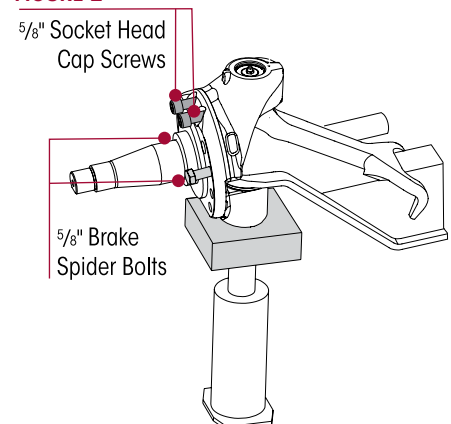

6. Install a bottle jack under the lower knuckle and slightly raise the knuckle until it is possible to thread in the (3) brake backing plate bolts by hand. These are for guide purposes only.
7. Snug the two (2) socket head cap screws, see Figure 2.
8. Lower the bottle jack so that all the vertical end play is on the underside of the axle.
9. Affix a magnetic base dial indicator on the axle and place the tip of the dial indicator on top of the knuckle assembly, see Figure 3.
10. Zero the dial indicator.



11. Raise the bottle jack until there is **NO CLEARANCE** between the knuckle assembly and the bottom of the axle, slightly lifting the axle.
12. Check the reading on the dial indicator. The specification for vertical travel on the steering knuckle during assembly is 0.008" to 0.011".
13. If the clearance is:

Above 0.011", loosen the socket head cap screws and **push down** on the knuckle assembly until the proper vertical end play is achieved

Below 0.008", loosen the two (2) socket head cap screws and **pull up** on the knuckle assembly until the proper vertical end play is achieved

- **Further adjustment** for vehicles equipped with a **STEERTEK** axle ONLY
The vertical end play can be further adjusted with a shim. If the vertical clearance is above 0.011", add a 0.005" shim, if the vertical clearance is below 0.008", it may be necessary to remove a 0.005" shim

FIGURE 3

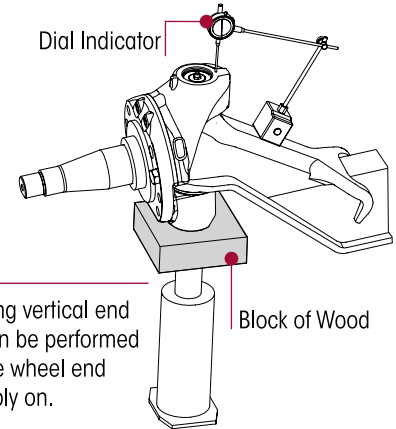

NOTE
Checking vertical end play can be performed with the wheel end assembly on.

NOTE

Hendrickson Genuine socket head cap screws come with a pre-applied Loctite compound.

WARNING

PRIOR TO INSTALLATION ENSURE THAT ALL RESIDUAL LOCTITE MATERIAL IS REMOVED FROM THE MOUNTING BOLTS AND THE THREAD BORES IN THE UPPER STEERING KNUCKLE, AND NEW LOCTITE 277 OR EQUIVALENT IS APPLIED TO HELP ENSURE THAT THE BOLTS SUSTAIN THE PROPER TORQUE REQUIREMENT. FAILURE TO DO SO CAN CAUSE LOSS OF VEHICLE CONTROL RESULTING IN PERSONAL INJURY OR PROPERTY DAMAGE.

14. Remove one (1) old socket head cap screw and replace with new socket head cap screw.
15. Remove second socket head cap screw and replace with new socket head cap screw. Tighten both socket head cap screws to \mathbb{N} 188 ± 12 foot pounds torque.
16. Recheck the vertical end play with the dial indicator or a 0.010" feeler gauge, see Figures 3 and 4.

FIGURE 4



17. Remove the brake spider bolts, they should thread out freely.
18. Remove the bottle jack and continue assembling the wheel ends.

IMPORTANT NOTE

It is critical to apply Loctite to the three (3) brake spider bolts to ensure that these bolts sustain the proper torque requirement of steering knuckle assembly.

19. Apply Loctite to the three (3) brake spider bolts prior to installation into the brake spider. Tighten bolts to \mathbb{N} 188 ± 12 foot pounds torque.

WARNING

DO NOT GREASE KNUCKLES WITHOUT THE BRAKE SPIDER INSTALLED AND TIGHTENED TO PROPER TORQUE. FAILURE TO DO SO CAN CAUSE COMPONENT DAMAGE RESULTING IN FAILURE AND LOSS OF VEHICLE CONTROL, POSSIBLY CAUSING PERSONAL INJURY OR PROPERTY DAMAGE.

20. Install the tie rod end into the lower steering knuckle arm.
21. Tighten the castle nuts to \mathbb{N} 185 foot pounds torque then rotate the castle nut to the next castle slot and install cotter pin.



- 22. Install the drag link into the steering arm and tighten to the vehicle manufacturer's specifications.
- 23. Install new O-rings on the grease caps and lubricate O-rings with grease.
- 24. **STEERTEK NXT** axle – Install new grease caps. Note the grease caps on the STEERTEK NXT axle are threaded, tighten to  60 ± 10 foot pounds torque. Allow 30 minutes for thread sealant to cure before greasing. Install new grease Zerk and tighten to a minimum of 15 foot pounds, see Figure 5.

STEERTEK axle – Install new grease caps and retaining rings.

FIGURE 5

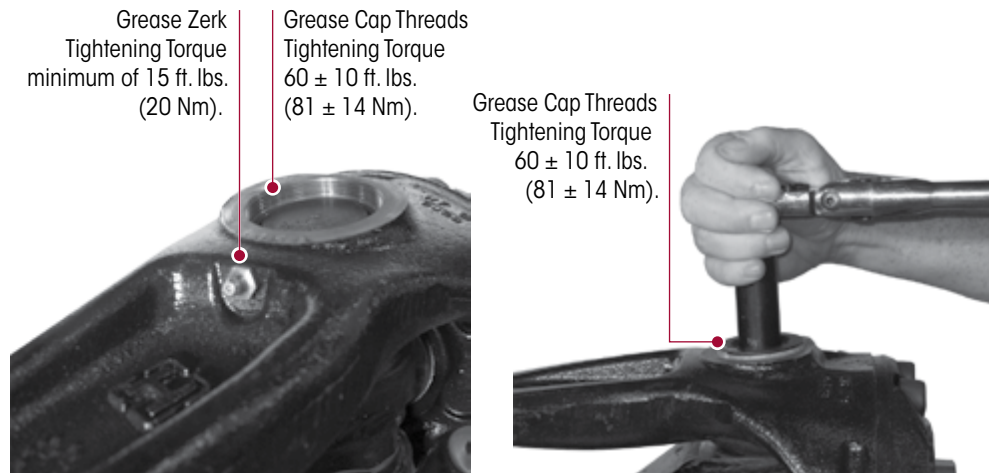

- 25. Install brakes, drums, wheels and tires.
- 26. Remove jack and safety stands.
- 27. Grease steering knuckles with the vehicle on the floor.
- 28. Remove the wheel chocks.

Refer any questions on this publication, contact Hendrickson Tech Services:



Toll-free U.S. and Canada
1.866.755.5968
Outside U.S. and Canada
1.630.910.2800



Parts Identification
truckparts@hendrickson-intl.com
Technical Support
techservices@hendrickson-intl.com



1.630.910.2899



Additional Hendrickson
Product Information
www.hendrickson-intl.com

Call Hendrickson at **1.866.755.5968** (toll-free) or **1.630.910.2800** for additional information.



www.hendrickson-intl.com

TRUCK COMMERCIAL VEHICLE SYSTEMS
800 South Frontage Road
Woodridge, IL 60517-4904 USA
1.866.755.5968 (Toll-free U.S. and Canada)
1.630.910.2800 (Outside U.S. and Canada)
Fax 1.630.910.2899

59310-017 Rev C 05-20

© 2008 – 2020 Hendrickson USA, L.L.C. All Rights Reserved. All trademarks shown are owned by Hendrickson USA, L.L.C., or one of the affiliates, in one or more countries. Information contained in this literature was accurate at the time of publication. Product changes may have been made after the copyright date that are not reflected.

Printed in United States of America