

H TECHNICAL PROCEDURE

TIREMAAX® EC TIRE INFLATION SYSTEM

SUBJECT: TIREMAAX EC Hand-Held
Programming Device Operation

LIT NO: L867

DATE: June 2007

REVISION: A



TABLE OF CONTENTS

| | |
|---|----|
| INTRODUCTION | 3 |
| HAND-HELD PROGRAMMING DEVICE CONNECT PROCEDURE | 3 |
| TARGET PRESSURE SETTING | 6 |
| DIAGNOSTIC TEST OPERATION | 8 |
| FAULT CODE HISTORY OPERATION | 10 |
| HAND-HELD PROGRAMMING DEVICE DISCONNECT PROCEDURE | 11 |



This document is only applicable to TIREMAAX® EC systems. It describes the operation of the hand-held programming device used to program pressure settings, run diagnostics and display fault code history for the TIREMAAX EC system.

The descriptions and specifications contained in this publication are current at the time of printing.

Hendrickson reserves the right to discontinue or modify its models and / or procedures and to change specifications at any time without notice.

Any reference to brand name in this publication is made as an example of the types of tools and materials recommended for use and should not be considered an endorsement. Equivalents may be used.

IMPORTANT NOTICE

Hazard signal words (such as Warning or Caution) appear in various locations throughout this publication. Information accented by one of these signal words must be observed at all times. Additional notes are utilized to emphasize areas of procedural importance and provide suggestions for ease of repair. The following definitions indicate the use of these signal words as they appear throughout the publication.

⚠ WARNING: INDICATES HAZARDS OR UNSAFE PRACTICES WHICH COULD RESULT IN SEVERE PERSONAL INJURY OR DEATH.

⚠ Caution: Indicates hazards or unsafe practices which could result in damage to machine or minor personal injury.

NOTE: Additional service information not covered in the service procedures.

Departure from the instructions, choice of tools, materials and recommended parts mentioned in this publication may jeopardize the personal safety of the service technician or vehicle operator.

Always use genuine Hendrickson replacement parts.

Every effort has been made to ensure the accuracy of all information in this publication. **However, Hendrickson makes no expressed or implied warranty or representation based on the enclosed information.**



HAND-HELD PROGRAMMING DEVICE OPERATION

INTRODUCTION

The optional hand-held programming device is used to:

- Program a target pressure setting other than the factory preset value
- Run diagnostics
- Display fault code history

NOTE: The hand-held programming device is not required to identify the fault that caused the trailer mounted warning lamp to illuminate. Before power is removed from the trailer, the LED on the controller assembly will blink a code associated with the fault that caused the warning lamp to illuminate (refer to the blink code descriptions in Hendrickson publication L818, *TIREMAAX® Installation, Service and Troubleshooting Procedures* for more details). However if the blink code was not observed before power was removed from the trailer, the hand-held programming device will be needed to reveal the last fault code stored before power was removed.

To use the hand-held programming device for any of these tasks, it must first be connected to the TIREMAAX® EC controller assembly, between the pressure sensors and the ECU. When connected, the hand-held programming device will be powered from the trailer power circuit and is ready for use. No additional power supplies or on / off switches are required to use the hand-held programming device.

Use the following procedure to connect the hand-held programming device to the controller assembly.

IMPORTANT: Do not vary the connection order from what is presented in the following steps. The last connection made must be the four-pin trailer power cable into the hand-held programming device.

HAND-HELD PROGRAMMING DEVICE CONNECT PROCEDURE

1. Power the trailer.

The hand-held programming device derives power from the trailer, so the trailer must be powered for the hand-held programming device to function.

NOTE: Do not plug the four-pin trailer power cable into the hand held programming device at this time. This connection must be the last one made in order for the hand-held programming device to properly enter the target pressure setting mode.

2. Pressurize the trailer air tank (optional).

If you wish to run the diagnostics to functionally check the solenoid valves and pressure sensors, the trailer must have enough air pressure (90 psi) to open the pressure protection valve on the trailer air tank. If you do not wish to run the diagnostics, this step can be skipped.

⚠ CAUTION: Potential overinflation hazard. When performing diagnostics, the trailer air tank pressure **MUST NOT** be higher than the target pressure setting.

If the trailer air tank pressure is higher, the tires will overinflate when both supply and delivery solenoid valves are opened at the same time. No method exists to exhaust the overinflated tires, other than disconnecting the tire hoses and manually depressing the valve stem core at each tire.

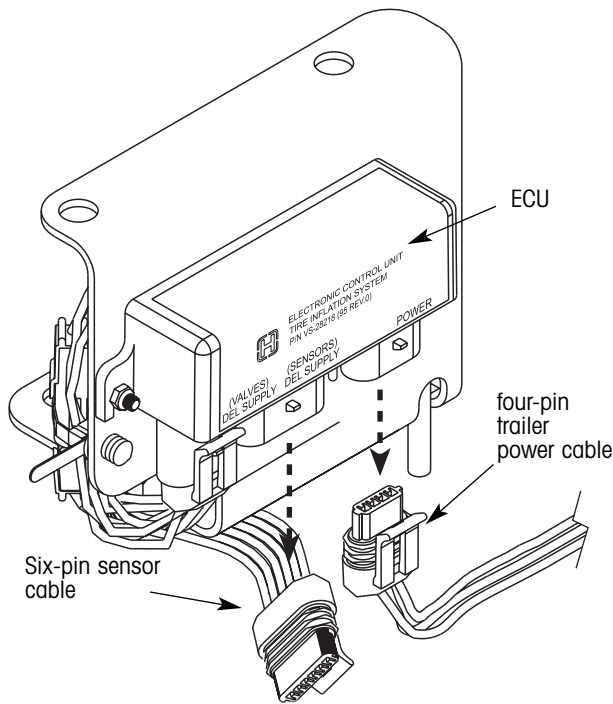

Figure 1. Unplugging the power and sensor cables

3. Unplug the four-pin trailer power cable from the controller assembly ECU (figure 1).

NOTE: To unplug the connectors, insert the tip of a small flat blade screwdriver into the slot on the connector tab and **GENTLY** push down on the screwdriver to disengage the tab from the interlocking pin (figures 2 and 3). With the tab disengaged, gently pull the connector apart (figure 3). **DO NOT** overbend the tab. Even though the connector is made of a resilient plastic, it is possible to damage the connector if excessive force is used.

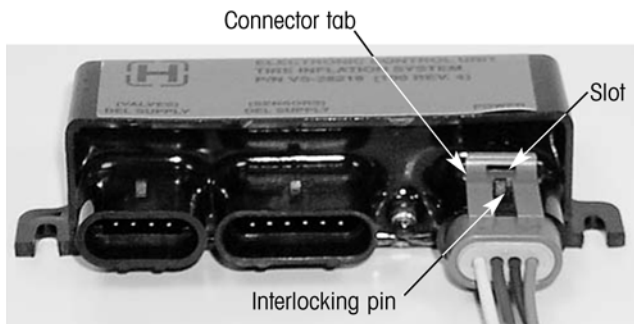

Figure 2. Typical connector items

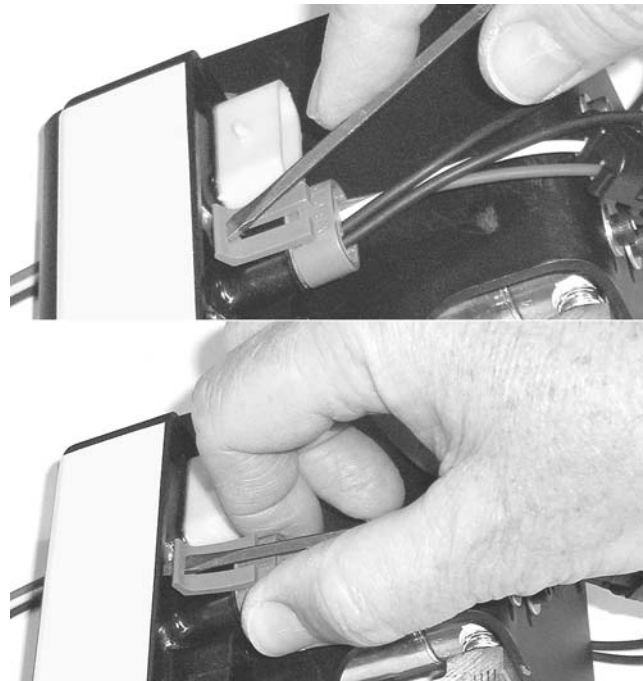

Figure 3. Connector unplugging technique

4. Unplug the six-pin sensor cable from the controller assembly ECU (figure 1).
5. Plug the four-pin connector from the hand-held programming device into the open four-pin socket on the controller assembly ECU (connection A, figure 4, the four-pin socket next to the LED).
6. Plug the six-pin connector from the hand-held programming device into the open six-pin socket on the controller assembly ECU (connection B, figure 4).
7. Plug the six-pin sensor cable from the controller assembly into the six-pin socket on the hand-held programming device (connection C, figure 4).
8. Plug the four-pin trailer power cable into the four-pin socket on the hand-held programming device (connection D, figure 4).



TIREMAAX® EC HAND-HELD PROGRAMMING DEVICE OPERATION

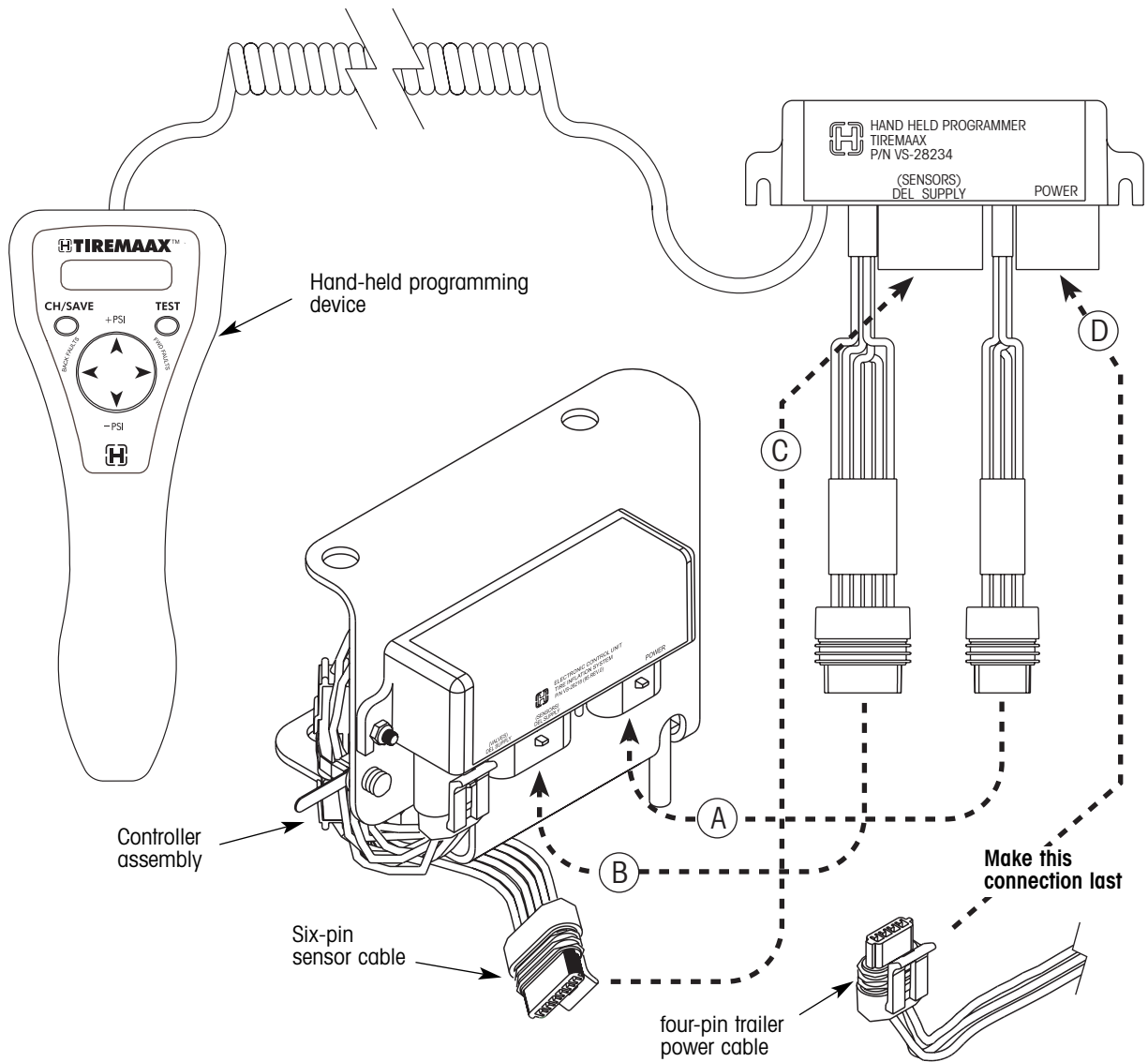

Figure 4. Connecting the hand-held programming device to the controller assembly ECU



When connected as described, the hand-held programming device will automatically enter the tire pressure setting mode. The tire pressure setting mode displays the present target pressure setting in the upper right corner of the display (figure 5).

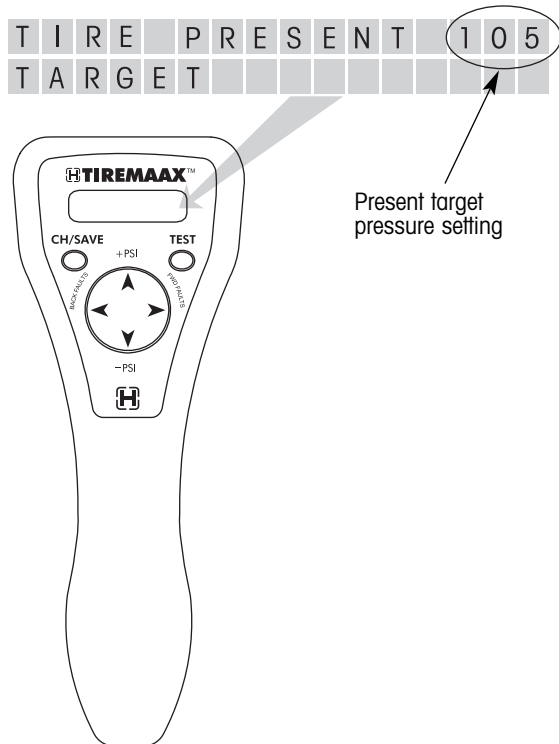

Figure 5. Initial target pressure setting mode display

If you don't see this screen on the hand-held programming device, unplug everything and reconnect the hand-held programming device in the order previously described. Make sure the last connection made is the four-pin trailer power cable to the hand-held programming device.

The hand-held programming device has three operational modes:

- target pressure setting mode
- diagnostic test mode
- fault code history mode

The target pressure setting mode is always the first mode entered when the hand-held programming device is powered. To navigate to the other operational modes, use the TEST button, BACK FAULTS or FWD FAULTS arrows, and the +PSI or -PSI arrows as shown in figure 6.

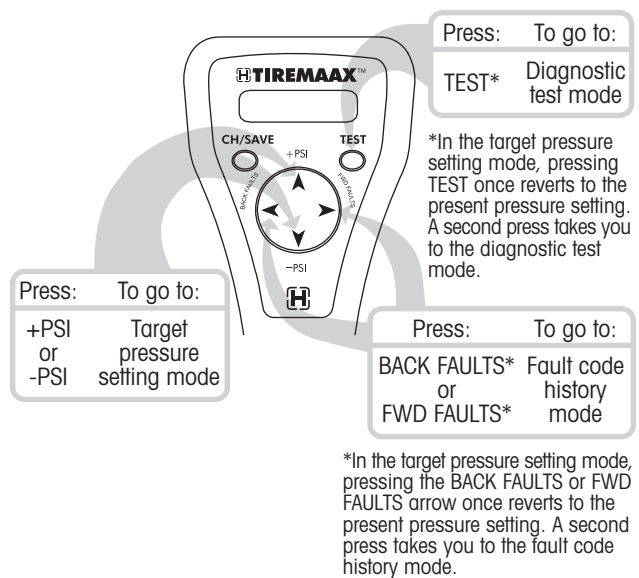

Figure 6. Navigating through the operational modes

TARGET PRESSURE SETTING

The target pressure setting mode is used to program a different tire pressure setting into the TIREMAAX® EC controller.

NOTE: For TIREMAAX EC to function properly, the trailer air tank pressure must be higher than the target tire pressure. TIREMAAX EC is only capable of allowing available air tank pressure to reach the tires. It is not capable of supplying pressure above the available air tank pressure.

When the target pressure setting mode is entered, the display shows the present target pressure setting (figure 5). This screen provides a visual indication that you are in the target pressure setting mode.

1. To select a different pressure setting:

Press the +PSI arrow on the direction pad to increase the target pressure setting or the -PSI arrow on the direction pad to decrease the target pressure setting (figure 7).

Each time the +PSI or -PSI arrow is pressed, the target pressure setting is raised or lowered by five psi and the display shows the newly selected pressure setting (figure 7). Possible target pressure settings are 70, 75, 80, 85, 90, 95, 100, 105, 110, 115, 120, 125 and 130.



2. Press the TEST button to cancel or reset the new target pressure setting. The lower right corner of the display will clear and the upper right corner of the display will revert to the present (or saved) target pressure setting (the same pressure setting that was in effect when the target pressure setting mode was first entered).

In the target pressure setting mode, before the CH/SAVE button is pressed, one press of the TEST button, BACK FAULTS or FWD FAULTS arrow acts as a "reset" or "do over" function. A second press of the TEST button changes focus to the diagnostic mode, and a second press of the BACK FAULTS or FWD FAULTS arrow changes focus to the fault code history mode.

3. Press the CH/SAVE (change / save) button to save the new target pressure setting (figure 8).

The display will show the newly selected pressure setting in the upper right corner of the display as the present target pressure setting.

4. Disconnect the hand-held programming device or go to one of the other operational modes.

If you wish to disconnect the hand-held programming device, refer to the disconnect procedure on page 11 (the four-pin trailer power cable must be the first one disconnected from the hand-held programming device and the last one connected to the controller assembly ECU).

| | | | | | | | | | | | | |
|---|---|---|---|---|---|---|---|---|---|---|---|---|
| T | I | R | E | P | R | E | S | E | N | T | 9 | 5 |
| T | A | R | G | E | T | | | | | | | |

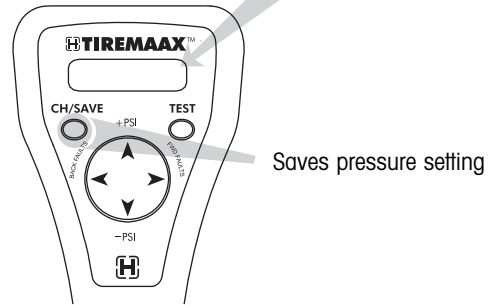

Figure 8. Saving the new target pressure setting

If you wish to go to the diagnostic test mode, press the TEST button.

If you wish to go to the fault code history mode, press either the BACK FAULTS or FWD FAULTS arrow on the direction pad.

| | | | | | | | | | | | | | |
|---|---|---|---|---|---|---|---|---|---|---|---|---|---|
| T | I | R | E | P | R | E | S | E | N | T | 1 | 0 | 5 |
| T | A | R | G | E | T | N | E | W | 9 | 5 | | | |

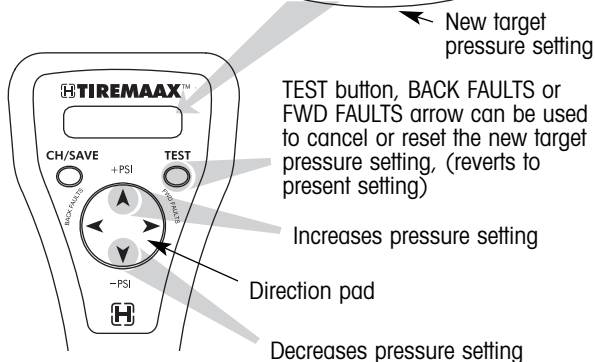

Figure 7. Selecting a different target pressure setting



DIAGNOSTIC TEST OPERATION

The diagnostic test mode can be used to toggle the trailer mounted warning lamp and controller assembly LED, the delivery solenoid valve and the supply solenoid valve on and off to see if these components respond properly. The diagnostic test mode also displays delivery and supply pressure sensor outputs in psi.

NOTE: Temporarily disconnect (unscrew) a wheel hose at the tee fitting on the wheel after entering the diagnostic test mode. This will prevent inadvertent tire overinflation during solenoid valve response testing when both supply and delivery solenoids are opened at the same time.

When the diagnostic test mode is entered, the display shows the supply and delivery pressure sensor outputs and the current state of the trailer mounted warning lamp (figure 9). This screen provides a visual indication that you are in the diagnostic test mode.

1. To test the trailer mounted warning lamp and controller assembly LED response:

| | | | | | | | | | | | | | | | | |
|---|---|---|--|---|---|---|--|--|--|--|--|---|---|---|---|---|
| S | U | P | | D | E | L | | | | | | L | A | M | P | |
| 1 | 3 | 0 | | | | 0 | | | | | | | | O | F | F |

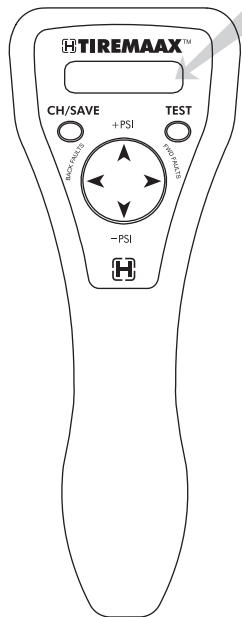

Figure 9. Initial diagnostic test mode display

| | | | | | | | | | | | | | | | | |
|---|---|---|--|---|---|---|--|--|--|--|--|---|---|---|---|--|
| S | U | P | | D | E | L | | | | | | L | A | M | P | |
| 1 | 3 | 0 | | | | 0 | | | | | | | | O | N | |

Display toggles with each press of the CH/SAVE button

| | | | | | | | | | | | | | | | | |
|---|---|---|--|---|---|---|--|--|--|--|--|---|---|---|---|---|
| S | U | P | | D | E | L | | | | | | L | A | M | P | |
| 1 | 3 | 0 | | | | 0 | | | | | | | | O | F | F |

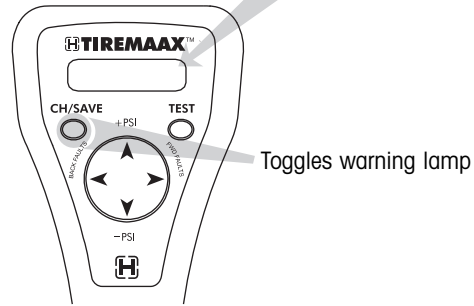

Figure 10. Testing the trailer mounted warning lamp and controller assembly LED response

Press the CH/SAVE (change / save) button to toggle the trailer mounted warning lamp and LED from off to on (figure 10). Press the CH/SAVE button again to toggle from on to off.

The trailer mounted warning lamp and controller assembly LED will remain in the last state chosen (either on or off) when the diagnostic focus is changed in the next step.

| | | | | | | | | | | | | | | | | |
|---|---|---|--|---|---|---|--|---|---|---|--|---|---|---|---|---|
| S | U | P | | D | E | L | | | | | | V | A | L | V | E |
| 1 | 3 | 0 | | | | 0 | | S | U | P | | O | F | F | | |

Display toggles with each press of the CH/SAVE button

| | | | | | | | | | | | | | | | | |
|---|---|---|--|---|---|---|--|---|---|---|--|---|---|---|---|---|
| S | U | P | | D | E | L | | | | | | V | A | L | V | E |
| 1 | 3 | 0 | | | | 0 | | S | U | P | | O | N | | | |

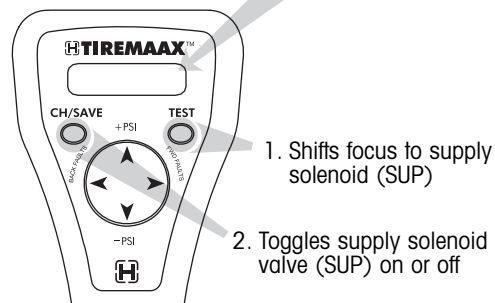

Figure 11. Testing the supply solenoid valve (SUP) response



- To test the supply solenoid valve response, press the TEST button (figure 11). The diagnostic focus shifts from the warning lamp to the supply solenoid valve.

Press the CH/SAVE (change / save) button to toggle the supply solenoid valve from off to on. Press the CH/SAVE button again to toggle the valve from on to off (figure 11).

CAUTION: Potential overinflation hazard. When performing diagnostics, the trailer air tank pressure **MUST NOT** be higher than the target pressure setting.

If the trailer air tank pressure is higher, the tires will overinflate when both supply and delivery solenoid valves are opened at the same time. No method exists to exhaust the overinflated tires, other than disconnecting the tire hoses and manually depressing the valve stem core at each tire.

The supply solenoid valve will remain in the last state chosen (either on or off) when the diagnostic focus is changed in the next step.

- To test the delivery solenoid valve response, press the TEST button (figure 12). The diagnostic focus shifts from the supply solenoid valve to the delivery solenoid valve.

Press the CH/SAVE button to toggle the delivery solenoid valve from off to on. Press the CH/SAVE button again to toggle the valve from on to off (figure 12).

The delivery solenoid valve will remain in the last state chosen (either on or off) when shifting to another mode of operation.

When warning lamp and solenoid valve response testing is complete, set all responses to the OFF state and reconnect the wheel hose at the tee fitting.

- Disconnect the hand-held programming device or go to one of the other operational modes.

If you wish to disconnect the hand-held programming device, refer to the disconnect

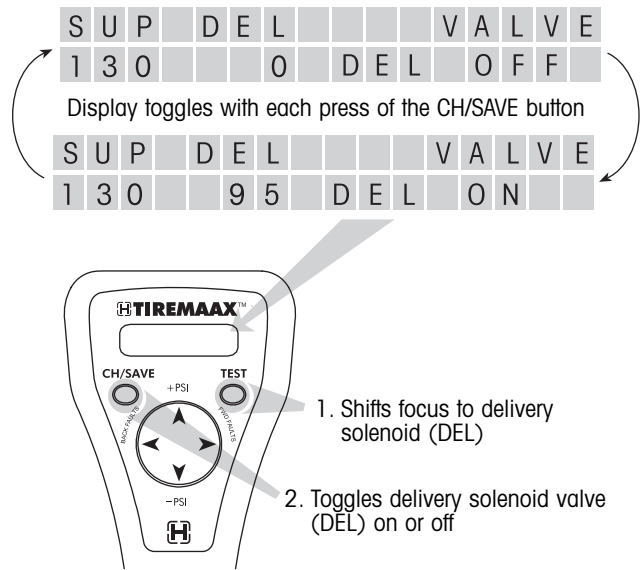

Figure 12. Testing the delivery solenoid valve (DEL) response

procedure on page 11 (the four-pin trailer power cable must be the first one disconnected from the hand-held programming device and the last one connected to the controller assembly ECU).

If you wish to go to the target pressure setting mode, press the +PSI or -PSI arrow on the direction pad.

If you wish to go to the fault code history mode, press the BACK FAULTS or FWD FAULTS arrow on the direction pad.



| | | | | | | | | | | | | | | | |
|---|---|---|---|---|---|---|---|---|---|---|---|---|---|---|---|
| L | A | S | T | | F | A | U | L | T | | C | O | D | E | 2 |
| C | H | E | C | K | | V | A | L | V | E | | L | E | A | K |
| 2 | N | D | | F | A | U | L | T | | C | O | D | E | 4 | |
| N | O | | P | S | I | / | | L | O | W | | T | A | N | K |
| 3 | R | D | | F | A | U | L | T | | C | O | D | E | 4 | |
| N | O | | P | S | I | / | | L | O | W | | T | A | N | K |
| 4 | T | H | | F | A | U | L | T | | C | O | D | E | 1 | |
| T | I | R | E | | T | O | P | S | I | | L | O | W | | |
| ⋮ | | | | | | | | | | | | | | | |
| 6 | T | H | | F | A | U | L | T | | C | O | D | E | 3 | |
| L | I | N | E | | / | | T | I | R | E | | L | E | A | K |

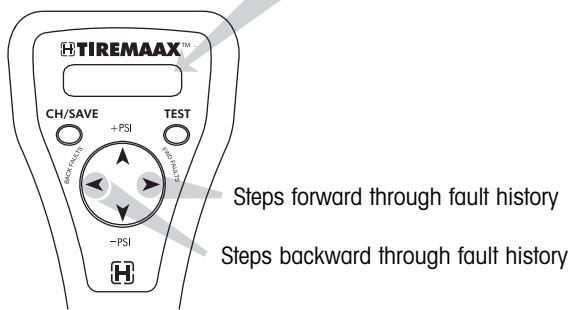

Figure 15. Stepping through the fault code history

When the controller is repowered, it will go into its normal operating mode. As the controller proceeds through its system routines, it will assume the fault has been corrected.

If the fault was not fixed, the controller will detect it and the LED on the controller assembly will blink the fault code. This LED blink code will be adequate to diagnose issues until resolved, without needing to re-attach the hand-held programming device. Every time power is removed from the controller and then reapplied, it will assume the fault has been corrected and will not repeat a fault code unless it detects the same one again.

A fault code will not be stored as a repeated code unless the same fault is the first one recorded after a power up. If the same fault is displayed in two consecutive locations in the fault code history, the fault was re-detected after controller power was reconnected.

It is not possible to clear faults from the register. When a new fault is detected, it becomes the last fault and all pre-existing faults shift one location. The last location, the sixth fault, gets overwritten.

3. Disconnect the hand-held programming device or go to one of the other operational modes.

If you wish to disconnect the hand-held programming device, refer to the following disconnect procedure (the four-pin trailer power cable must be the first one disconnected from the hand-held programming device and the last one connected to the controller assembly ECU).

If you wish to go to the target pressure setting mode, press the +PSI or -PSI arrow on the direction pad.

If you wish to go to the diagnostic test mode, press the TEST button twice. Pressing the TEST button once takes you to the target pressure setting mode. The second press will take you to the diagnostic test mode.

HAND-HELD PROGRAMMING DEVICE DISCONNECT PROCEDURE

1. Unplug the four-pin trailer power cable from the hand-held programming device. Do not plug this connector back into the controller assembly ECU at this time, it will be reconnected in step six.
2. Unplug the six-pin sensor cable from the hand-held programming device.
3. Unplug the hand-held programming device six-pin connector from the controller assembly ECU.
4. Unplug the hand-held programming device four-pin connector from the controller assembly ECU.
5. Plug the six-pin sensor cable back into the six-pin connector on the controller assembly ECU.
6. Plug the four-pin trailer power cable back into the four-pin connector on the controller assembly ECU.
7. Observe the LED on the controller assembly. Make sure it does not blink a fault code associated with loose or leaking tire hoses.

www.hendrickson-intl.com



Trailer Suspension Systems
250 Chrysler Drive, Unit #3
Brampton, ON Canada L6S 6B6
905.789.1030
Fax 905.789.1033

Trailer Suspension Systems 866.RIDEAIR (743.3247)
2070 Industrial Place SE 330.489.0045
Canton, OH 44707-2641 USA Fax 800.696.4416

Trailer Suspension Systems
Av. Industria Automotriz #200
Parque Industrial Sliva Aeropuerto
Apodaca, N.L., México C.P. 66600
(52) 81 8288 1300
Fax (52) 81 8288 1301