

H[®] SELECTION GUIDE

Equalizing Beam and Components

LIT NO: 45745-147

DATE: September 2022

REVISION: F

CONTENTS

DESCRIPTION	PAGE
Introduction	2
Fabricated and Forged/Cast Beams	3
Equalizing Beam End Bushings Service Kits.	4
Equalizing Beam Center Bushings and End Plugs	5
Equalizing Beam with Bar Pin End Bushings	6-7
Equalizing Beam with Adapter Style End Bushings.	8-9
Heavy-duty Equalizing Beam with Adapter Style End Bushings	10-11
Equalizing Beams with Rotatable Bar Pin End Bushings	12

Equalizing Beam with Rotatable Bar Pin End Bushing



Bar Pin End Bushing with Shims



Bar Pin End Bushing without Shims



High Confinement Rubber Center Bushings



Bronze Center Bushings



Adapter Style End Bushing



Equalizing Beam

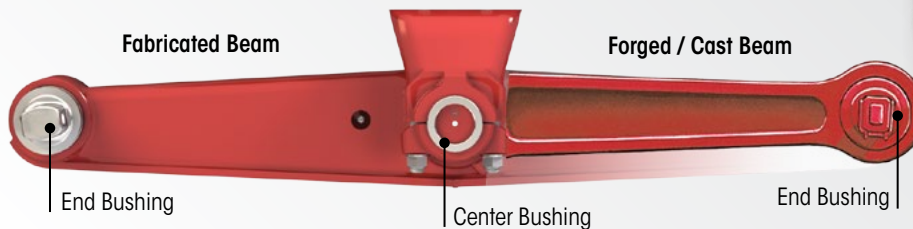

To learn more about Hendrickson Genuine Parts, call 1.866.755.5968 or visit www.hendrickson-intl.com

■ Introduction

This Equalizing Beam and Components Selection Guide is intended to aid in the proper identification for aftermarket replacement of originally equipped Hendrickson equalizing beams and other components. It helps determine the proper and complete beam assembly part numbers, end bushing service kit numbers and center bushing requirements.

■ Important Notes

- **Equalizing beams** are available for applicable Hendrickson suspensions with 34,000 pound to 120,000 pound capacity with axle spacing of 52"-72½". All Hendrickson equalizing beam assemblies include end bushings and center bushings (if equipped). Hendrickson **DOES NOT** supply equalizing beam assemblies without bushings.
- **Equalizing beam length** is measured from the centerline of one end hub to the centerline of the other end hub.

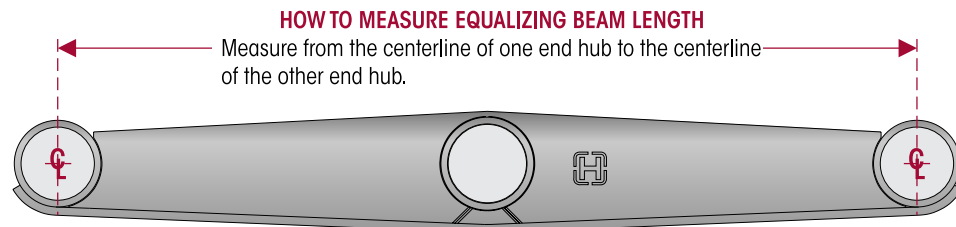

- **Fabricated equalizing beam** — Hendrickson introduced its fabricated equalizing beam design for up to 46,000 pound capacity between August 1999 and March 2000. In February 2008, it introduced a fabricated beam for 52,000 pound and up capacities. The fabricated beam is completely interchangeable with Hendrickson's discontinued forged beam.
- **Center bushing Part Number 29483-005** — **ALWAYS REQUIRES** the use of transverse torque rods. When using the fabricated style beams, the entire beam assembly must be replaced when converting from a rubber center bushing to a bronze center bushing to accommodate for the grease fitting and channel installation. **To convert** from rubber center bushings to bronze center bushings contact Hendrickson Truck Parts.
- **End bushings** — Both **shim and non-shim type Hendrickson bar pin** end bushings are completely interchangeable with **Hendrickson rotating bar pin** end bushings. Once pressed into the beam, the pins can be rotated to the correct angle for a perfect installation. The bushing pins become fixed at the required angle when the installation is properly completed. It helps save time and labor costs by eliminating re-work from incorrectly installed bushings. No special tools are required to rotate the bushing.



WARNING

FABRICATED BEAM ASSEMBLY ORIENTATION IT IS IMPORTANT THAT THE ORIENTATION OF THE BEAM BE IN THE UPRIGHT POSITION. A DECAL MAY BE AFFIXED TO THE TOP OF BEAM TO ASSIST IN ASSEMBLY AND TO VERIFY ORIENTATION. FAILURE TO INSTALL EQUALIZING BEAM PROPERLY MAY RESULT IN ADVERSE VEHICLE HANDLING AND POSSIBLE PERSONAL INJURY OR PROPERTY DAMAGE.



FABRICATED BEAMS

AR2™ • R™ • RS™ • RT™ • RTE™

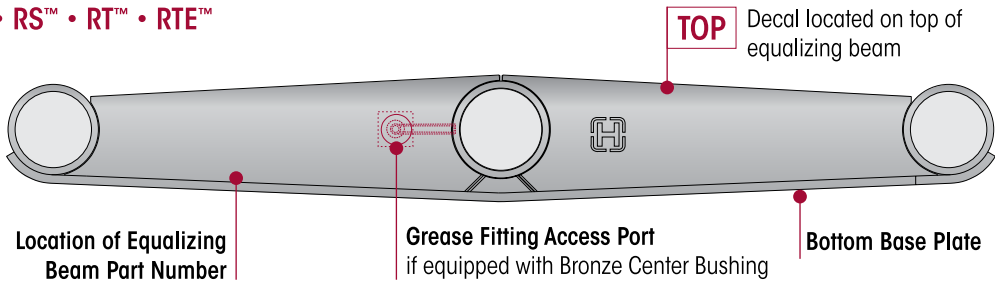

HAULMAAX® EX

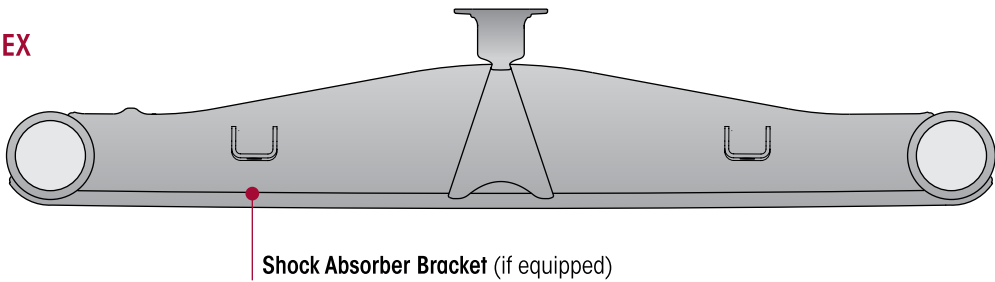

HAULMAAX®

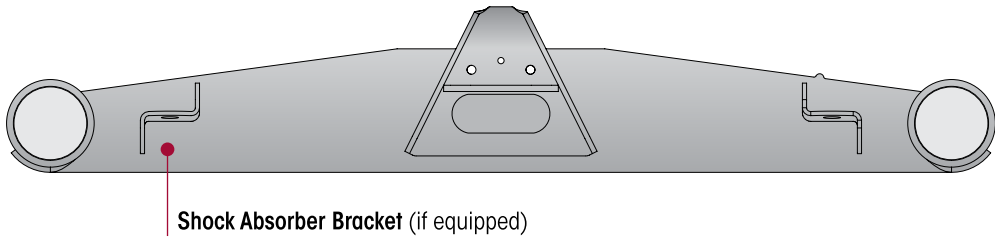

HN®

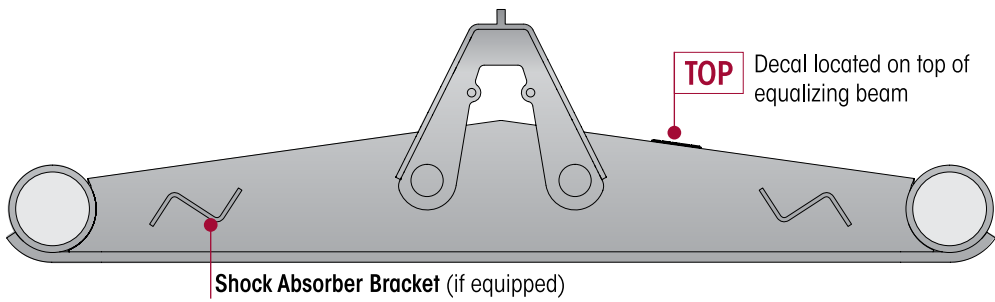

ULTIMAAX®

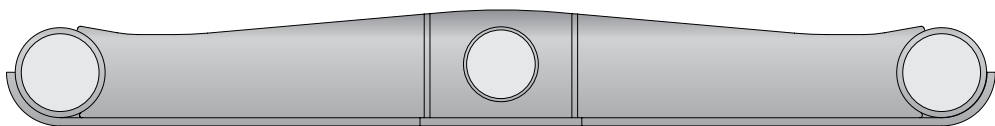

FORGED / CAST BEAMS

AR2 • R • RS • RT • RTE

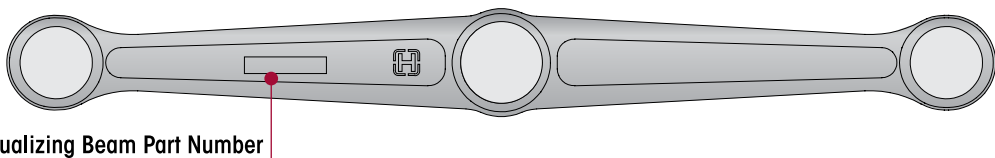



Equalizing Beam End Bushing Service Kits | AR2 • HAULMAAX EX • HAULMAAX • HN R • RS • RT • RTE • ULTIMAAX

Bar Pin End Bushing Service Kits

Two (2) kits required per beam

AR2 • HAULMAAX EX • HAULMAAX • HN • R • RS • RT • RTE

NON-SHIM TYPE



34013-087L

Qty.	Description
1	Bar Pin End Bushing
2	1"-8 UNC x 6" Hex Bolt
4	1" Hardened Washer
2	1"-8 UNC Locknut

SHIM TYPE, ROTATING BAR PIN



34013-188L

Qty.	Description
1	Bar Pin End Rotating Bushing
2	Bar Pin Shim 0.25" x 0.12"
2	1"-8 UNC x 6" Hex Bolt
4	1" Hardened Washer
2	1"-8 UNC Locknut

AR2 • HAULMAAX EX • HAULMAAX • HN R • RS • RT • RTE • ULTIMAAX
SHIM TYPE *Shown 34013-088L*



34013-088L • 60961-752 (ULTIMAAX Only)

Qty.	Description
1	Bar Pin End Bushing
2	Bar Pin Shim 0.25" x 0.12"
2	1"-8 UNC x 6" Hex Bolt
4	1" Hardened Washer
2	1"-8 UNC Locknut

Equalizing Beams End Bushing Service Kits | AR2 • R • RS • RT • RTE • ULTIMAAX

Adapter Style End Bushing Service Kits

Two (2) kits required per beam

HOW TO MEASURE ADAPTER STYLE END BUSHING LENGTH

Measure the end bushing to help determine the correct end bushing kit

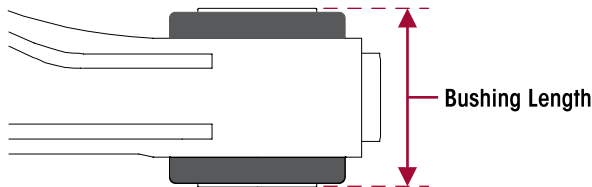

ADAPTER STYLE END BUSHING SERVICE KIT

Description	Quantity
Adapter Style End Bushing	1
Beam End Adapter	2
Adapter Tube	1
Hex Bolt	1
Hardened Washer	2
Locknut	1

CAPACITY RATING	END BUSHING LENGTH	END BUSHING PART NUMBER	END BUSHING SERVICE KIT
34K	5¼"	06969-000L	34013-048
34K through 46K	5¾"	45900-000L	34013-049
46K			34013-073
48K through 52K	5¾"	29878-001L	34013-050
52K	6"	45407-000L	34013-051
60K through 85K	6"	10363-000L	34013-052
	7"	10364-000L	34013-110

Bronze Tube and Nut Style End Bushing Service Kits

44K through 90K	4"	04990-000	34013-056
			34013-057



Equalizing Beams Center Bushings | AR2 • R • RS • RT • RTE • ULTIMAAX

Bronze Center Bushing Service Kits

One (1) kit required per beam

Rubber Center Bushings



BRONZE TUBE & NUT ENDS

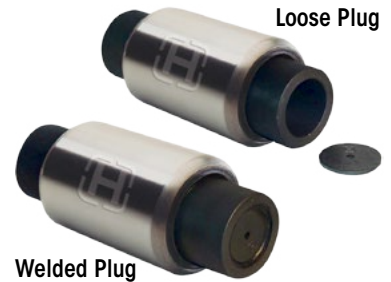

- 34013-053** 34K
- 34013-054** 38K•40K•44K•46K
48K•50K•52K
- 34013-055** 65K

- | Qty. | Description |
|------|-----------------------|
| 1 | Bronze Center Bushing |
| 1 | Beam Center Sleeve |
| 2 | Beam Center Seal |
| 4 | Thrust Washer |
| 1 | Grease Fitting |

- 34013-080** Solid Sleeve
- 34013-081** Hollow Sleeve
- 34013-078** Solid Sleeve
- 34013-079** Hollow Sleeve

- | Qty. | Description |
|------|-----------------------|
| 2 | Bronze Center Bushing |
| 1 | Beam Center Sleeve |
| 2 | Thrust Washer |

- | Part No. | Description |
|------------|-----------------------------------|
| | AR2 • R • RS • RT • RTE |
| 06664-000L | 34K•40K |
| 49400-000L | 34K•38K•40K |
| 05919-000L | 38K•40K |
| 29483-005L | 44K•46K•48K•50K•52K |
| 10366-000L | 65K |
| 15464-000 | 85K |
| 14110-000 | 100K•120K |
| | ULTIMAAX |
| 69538-000L | 46K•52K•54K•58K•60K•63K |
| 78676-001 | 70K, includes Circlip (Not Shown) |

Center Bushing End Plugs for Cross Tube Replacement | AR2 • R • RS • RT • RTE • ULTIMAAX

	SUSPENSION CAPACITY	RUBBER CENTER BUSHING ASSEMBLY PART NUMBER	END PLUG PART NUMBER	BRONZE CENTER SLEEVE PART NUMBER	END PLUG PART NUMBER
	*34K through 54K				
	34K	06664-000L	22278-000	14684-000	22278-000
		22279-000L			
	38K	05919-000L	22281-000	14685-000	57263-000
		22282-000L			
	40K	+ 49400-000L			
		+ 49600-000L			
	46K to 52K	29483-005L			
		34013-097L			

* On heavy-duty suspensions over a 52,000 pound capacity, Hendrickson recommends removal of both equalizing beams as part of cross tube replacement. Therefore center bushing end plugs are not available for these higher capacity suspensions. Refer to the applicable Technical Procedure Publications available online at www.hendrickson-intl.com for more information.

+ High confinement bushings.



Fabricated Equalizing Beams with Bar Pin End Bushings | AR2 • R • RS • RT • RTE • ULTIMAAX

EQUALIZING BEAM LENGTH	FABRICATION NUMBER	ASSEMBLY PART NUMBER		RUBBER / BRONZE CENTER BUSHING PART NUMBER	★ BAR PIN END BUSHING KIT NUMBER
		ORIGINAL	REPLACEMENT		
AR2 • R • RS • RT • RTE 34K • 40K					
52"	60855-002	50000-024		06664-000L	34013-087L
		50500-024			34013-088L
		◆ 50000-025	50500-025	49400-000L	
54"	60855-001	◆ 50000-027	◆ 50500-027	06664-000L	34013-087L
		50000-028		49400-000L	34013-088L
56"	67453-002	◆ 50000-010	50500-010		34013-087L
★ 60"	58755-003	50000-030			34013-088L
★ 72½"	29585-007	50500-030			34013-087L
		◆ 50000-014	50500-014		34013-088L
AR2 • R • RS • RT • RTE 46K					
52"	60855-002	◆ 50000-026	50500-026	★ 29483-005L	34013-088L
54"	60855-001	50000-029			34013-087L
		50500-029			34013-088L
★ 72½"	29585-007	50000-015			34013-087L
		50500-015			34013-088L
AR2 • R • RS • RT • RTE 48K • 50K • 52K					
52"	67091-520	50500-039		★ 29483-005L	34013-088L
54"	67091-540	50500-040			34013-087L
★ 60"	58755-003	50000-031			34013-088L
		50500-031			
★ 72½"	31121-030	◆ 50000-016	50500-016		
ULTIMAAX 46K • 52K • 54K • 58K					
52"	78488-520	78489-520		69538-000L	60961-752
54"	78488-540	78489-540			
56"	78488-560	78489-560			
60"	78488-600	78489-600			

AR2 • R • RS • RT • RTE 40K • 46K					
52"	67453-002	50001-015		34013-054	34013-087L
		50501-015			34013-088L
54"	67453-001	50001-017			34013-087L
		50501-017			34013-088L
AR2 • R • RS • RT • RTE 48K • 50K • 52K					
52"	67091-521	50501-021		34013-054	34013-088L
54"	67091-541	50501-022			



Fabricated Equalizing Beams with Bar Pin End Bushings | HAULMAAX • HN

EQUALIZING BEAM LENGTH	STYLE	FABRICATION NUMBER	ASSEMBLY PART NUMBER	★ BAR PIN END BUSHING KIT NUMBER
HAULMAAX 40K • 46K				
52"	With Shock Bracket	64830-003	64846-003	34013-088L
54"		64830-001	64846-001	
60"		64830-002	64846-002	
72½"		64830-004	64846-010	
52"	Without Shock Bracket	64836-003	64847-003	
54"		64836-001	64847-001	
		64836-001	64847-004	
60"		64836-002	64847-002	
72½"		64830-004	64847-010	
HN 40K				
52"		58348-002	57889-004	34013-087L
			57889-005	34013-088L
			57889-008	34013-088L
54"		58348-001	57889-001	34013-087L
			57889-002	34013-088L
HN 40K • 46K				
60"		58684-001	58494-005	34013-087L
			58494-006	34013-088L
72½"		58711-001	58494-009	34013-087L
			58494-010	34013-088L
HN 46K				
54"		58409-001	58494-001	34013-087L
			58494-002	34013-088L
HN 52K				
54"		59972-001	59973-003	34013-088L

**HAULMAAX EX • HAULMAAX • HN
BAR PIN STYLE END BUSHING KITS**

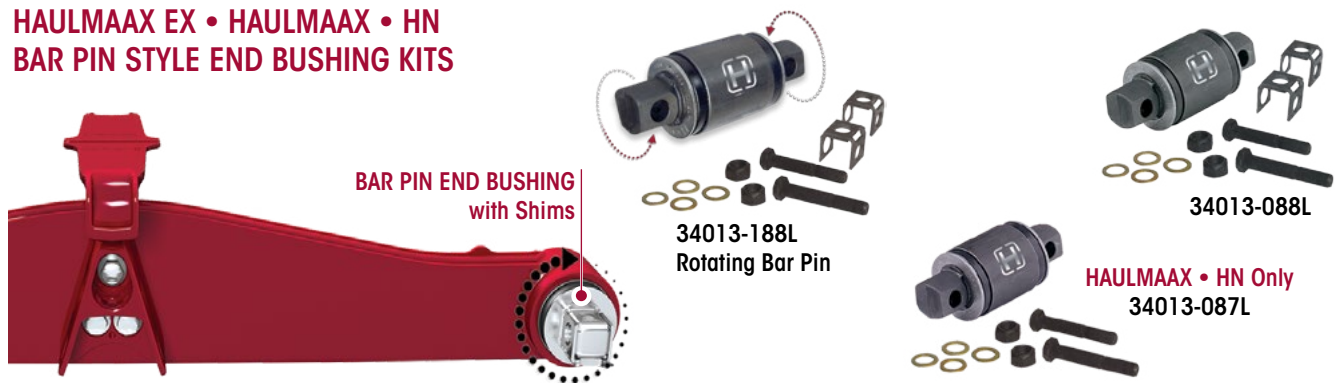

- ★ Requires transverse torque rods.
- ◆ Part number no longer in production, see Replacement Column or contact Hendrickson Truck Parts for available options.
- ⊛ Rotating bar pin end bushing with shims Kit Number 34013-188L can be used to replace Kit Numbers 34013-088L or 34013-087L and are completely interchangeable.



Fabricated Equalizing Beams with Adapter Style End Bushings | AR2 • R • RS • RT • RTE

EQUALIZING BEAM LENGTH	FABRICATION NUMBER	ASSEMBLY PART NUMBER		RUBBER CENTER BUSHING PART NUMBER	ADAPTER END BUSHING KIT NUMBER	END BUSHING LENGTH
		ORIGINAL	REPLACEMENT			
AR2 • R • RS • RT • RTE 34K						
50"	29584-007	◆ 07500-591		06664-000L	34013-048	5½" & 5¾"
		◆ 07500-592			34013-049	
52"	60855-002	07500-593				
54"	60855-001	◆ 07500-596				
60"	✚ 47480-000	07500-491				
AR2 • R • RS • RT • RTE 38K • 40K						
50"	29585-027	07500-458		05919-000L	34013-049	5¾"
52"	60855-002	07500-594		49400-000L		
54"	60855-001	07500-597				
★ 60"	58755-003	07500-599				
★ 72½"	29585-007	07500-553				
AR2 • R • RS • RT • RTE 44K • 46K						
52"	60855-002	07500-595		★ 29483-005L	34013-049	5¾"
54"	60855-001	07500-598				
★ 60"	58755-003	07500-600				
1700 mm	56735-000	07500-576				
★ 72½"	29585-007	07500-474				
AR2 • R • RS • RT • RTE 48K • 52K						
52"	67091-520	07500-606		★ 29483-005L	34013-050	5¾"
54"	67091-540	07500-608				
★ 60"	58755-003	07500-602				
★ 72½"	31121-030	07500-511				
AR2 • R • RS • RT • RTE 52K						
52"	67091-520	07500-607		★ 29483-005L	34013-051	6"
54"	67091-540	◆ 07500-609				
★ 60"	58755-003	07500-603				
★ 72½"	31121-030	◆ 07500-541	07500-474		34013-050	
76"	31121-024	07500-524				
80"	31121-032	07500-605				

RUBBER CENTER BUSHING

✚ Cast equalizing beam.

★ Requires transverse torque rods.

◆ Part number no longer in production, see Replacement Column or contact Hendrickson Truck Parts for available options.



Fabricated Equalizing Beams with Adapter Style End Bushings | AR2 • R • RS • RT • RTE

EQUALIZING BEAM LENGTH	FABRICATION NUMBER	ASSEMBLY PART NUMBER		BRONZE CENTER BUSHING KIT NUMBER	ADAPTER END BUSHING KIT NUMBER	END BUSHING LENGTH
		ORIGINAL	REPLACEMENT			
AR2 • R • RS • RT • RTE 34K						
52"	58755-002	30247-150	30247-151	34013-053	34013-049	5½" & 5¾"
54"	59068-001	30247-153				
AR2 • R • RS • RT • RTE 38K • 40K • 44K • 46K						
50"	46325-006	◆ 30247-111		34013-054	34013-049 with ¾" x 6½" Bolt 34013-073 with 1" x 10½" Bolt	5¾"
52"	67453-002	30247-151				
54"	67453-001	30247-153				
AR2 • R • RS • RT • RTE 48K • 52K						
52"	67091-521	30247-154		34013-054	34013-050	5¾"
		30247-155			34013-051	6"
54"	67091-541	30247-156			34013-050	5¾"
		30247-157			34013-051	6"

BRONZE CENTER BUSHING

AR2 • R • RS • RT • RTE



Bronze Center Bushing Kits

Kit Number	Capacity
34013-053	34K
34013-054	38K through 52K
34013-055	65K

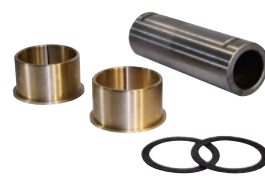

Bronze Center Bushing Kits for Tube and Nut Ends

Kit Number	
34013-080	Solid Sleeve
34013-078	Solid Sleeve
34013-081	Hollow Sleeve
34013-079	Hollow Sleeve



Adapter Style End Bushing Kits

Kit Number	Capacity
34013-048	34K
34013-049	34K through 46K
34013-073	46K
34013-050	48K through 52K
34013-051	52K
34013-052	60K through 85K
34013-110	60K through 85K

Bronze Tube and Nut Style

34013-056	44K through 90K
34013-057	44K through 90K



◆ Part number no longer in production, see Replacement Column or contact Hendrickson Truck Parts for available options.

Heavy-duty Equalizing Beams with Adapter Style End Bushings | R • RS • RT • RTE

EQUALIZING BEAM LENGTH	STYLE	CASTING/FABRICATION NUMBER	ASSEMBLY PART NUMBER		BRONZE CENTER BUSHING KIT NUMBER	ADAPTER END BUSHING KIT NUMBER	TOTAL OFFSET "A"	END BUSHING LENGTH
			ORIGINAL	REPLACEMENT				
R • RS • RT • RTE 65K								
56"	Fabricated	68650-561	◆ 30247-106	30247-159	34013-055	34013-052	2¾"	6"
60"		68650-601	◆ 30247-094	30247-161				
72"		31122-020	30247-130				2¼"	
56"	Fabricated	68650-561	◆ 30247-121	30247-162	34013-055	34013-110	3¼"	7"
60"		68650-601	◆ 30247-158	30247-160				

BRONZE CENTER BUSHING

Heavy-duty Equalizing Beams with Tube and Nut Ends | R • RS • RT • RTE

R • RS • RT • RTE 44K • 52K • 60K • 90K								
50"	Fabricated	30934-000	◆ 30644-001					
52"	Forged/ Cast	34876-000	◆ 30644-003		34013-054	34013-056	0"	
54"		33197-000	32649-000					
		◆ 11755-002	◆ 07600-011					
56"	Fabricated	46450-011	◆ 30644-008		34013-054	34013-056		
58"		◆ 26997-000	07600-132		34013-080 Solid Sleeve 34013-081 Hollow Sleeve	34013-057		
		◆ 07600-133			34013-078 Solid Sleeve 34013-079 Hollow Sleeve			

FIGURE 1 OFFSET

TOP VIEW

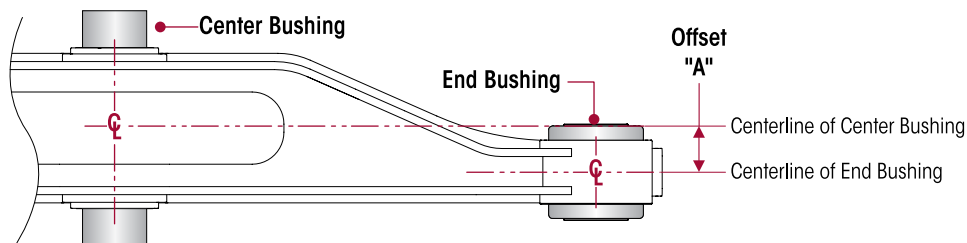

◆ Part number no longer in production, see Replacement Column or contact Hendrickson Truck Parts for available options.



Heavy-duty Equalizing Beams with Adapter Style End Bushings | R • RS • RT • RTE • ULTIMAAX





EQUALIZING BEAM LENGTH	STYLE	CASTING/FABRICATION NUMBER	ASSEMBLY PART NUMBER		RUBBER CENTER BUSHING PART NUMBER	ADAPTER END BUSHING KIT NUMBER	TOTAL OFFSET "A"	END BUSHING LENGTH
			ORIGINAL	REPLACEMENT				
R • RS • RT • RTE 65K								
50"	Fabricated	31122-002	07500-116		10366-000L	34013-052	1½"	6"
54"		31122-016	07500-454				2¾"	
		31122-017	07500-482				1½"	
56"	Cast	68650-560	◆ 07500-198	07500-613			2¾"	
		59409-000	◆ 07500-446				2¼"	
			07500-601					
60"		68650-600	◆ 07500-453	07500-612			2¾"	
64"	Fabricated	31122-010	07500-399		1½"			
75"		31122-009	07500-378		2"			
56"	Fabricated	68650-560	◆ 07500-490	07500-614	10366-000L	34013-110	3¼"	7"
60"		68650-600	◆ 07500-400	07500-611			1½"	
64"		31122-010	◆ 07500-532				1½"	
72"		31122-003	◆ 07500-214				1½"	
		31122-022	07500-581				2¼"	
R • RS • RT • RTE 85K								
56"	Fabricated	69250-002	◆ 07500-104	07500-617	15464-000	34013-110	2"	7"
58"		69250-005	◆ 07500-157	07500-620				
60"		69250-001	◆ 07500-182	07500-616				
		65410-000	07500-604					
64"		69250-003	◆ 07500-180	07500-618				
72"		69250-006	◆ 07500-068	07500-624				
75"		69250-004	◆ 07500-432	07500-619				
R • RS • RT • RTE 100K • 120K								
64"	Fabricated	67878-000	07500-579		14110-000	15424-000	3"	7¾"
80"		69571-000	◆ 07500-577	07500-615				
ULTIMAAX 60K • 63K • 70K								
54"	Fabricated	78633-540	78634-540		69538-000L	34013-052		6"
56"		78633-560	78634-560					
60"		78633-600	78634-600					
56"		78633-560	80291-560			34013-110		7"
60"		78633-600	80291-600					
56"		78633-560	80192-560					
60"		78633-600	80192-600					

◆ Part number no longer in production, see Replacement Column or contact Hendrickson Truck Parts for available options.



Aftermarket Equalizing Beams with Rotatable Bar Pin End Bushings | HAULMAAX EX • HAULMAAX • HN • RT/RTE • RS • R

Hendrickson offers rotatable bar pin end bushings on select equalizing beams for service with the exact equalizing beam used in production that provides structural integrity and functionality to maintain the original system performance.

	CAPACITY	EQUALIZING BEAM LENGTH	ASSEMBLY PART NUMBER			
			Equipped with Shock Bracket		Equipped without Shock Bracket	
			PRODUCTION	SERVICE	PRODUCTION	SERVICE
HAULMAAX EX						
	40K • 46K	52"	91373-520	91373-520R	91373-521	91373-521R
		54"	91373-540	91373-540R	91373-541	91373-541R
		60"	91373-600	91373-600R	91373-601	91373-601R
	46K	72.5"	91373-725	91373-725R	91373-726	91373-726R
	52K	52"	91383-520	91383-520R	91383-521	91383-521R
		54"	91383-540	91383-540R	91383-541	91383-541R
60"		91383-600	91383-600R	91383-601	91383-601R	
HAULMAAX						
	40K • 46K	54"	64846-001	80225-001	64847-001 64847-004	80226-001
HN						
	40K • 46K	52"	-	-	57889-008	80228-008
		54"	-	-	58494-002	80227-002
RT • RTE • RS • R						
	46K with Bronze Center Bushing	52"	-	-	50501-015	80476-015
		54"	-	-	50501-017	80476-017
	46K with Rubber Center Bushing	52"	-	-	50500-026	93024-026
		54"	-	-	50500-029	93024-029

Actual product performance may vary depending upon vehicle configuration, operation, service and other factors. All applications must comply with applicable Hendrickson specifications and must be approved by the respective vehicle manufacturer with the vehicle in its original, as-built configuration. Contact Hendrickson for additional details regarding specifications, applications, capacities, and operation, service and maintenance instructions.

Call Hendrickson at 1.866.755.5968 (toll-free) or 1.630.910.2800 for additional information.



www.hendrickson-intl.com

TRUCK COMMERCIAL VEHICLE SYSTEMS
 800 South Frontage Road
 Woodridge, IL 60517-4904 USA
 1.866.755.5968 (Toll-free U.S. and Canada)
 1.630.910.2800 (Outside U.S. and Canada)
 Fax 1.630.910.2899

45745-147 Rev F 09-22

© 2001 – 2022 Hendrickson USA, L.L.C. All Rights Reserved. All trademarks shown are owned by Hendrickson USA, L.L.C., or one of the affiliates, in one or more countries.

Information contained in this literature was accurate at the time of publication. Product changes may have been made after the copyright date that are not reflected.

Printed in United States of America